



## International Journal of Control Theory and Applications

ISSN : 0974-5572

© International Science Press

Volume 9 • Number 48 • 2016

### MPPT Technique for Wind Energy Conversion System Driven By PMSG

**R. Yeswanth Deekshith, A. Sriharibabu and K. Sai Venkata Ratnam**

*PG Student., Dept. of EEE, VFSTR University, Vadlamudi, Guntur, A. P, 522213, E-mail: yeswanth245@gmail.com*

**Abstract:** MPPT technique for wind energy conversion system driven by PMSG presented in this paper. Wind and solar energies are non-polluted and low operating cost. Open winding permanent magnetic machine is a robust construction, it has high reliability because there is no mutual influence between the stator windings, overcome the difficulties in voltage regulation, simplifying the system structure and control modules also reduced here. In this proposed system MPPT control module plays a vital role to obtain maximum power from optimum speed. Here we use Fuzzy logic control method to track maximum power from the wind turbine. The proposed system is simulated in MATLAB or Simulink to know the results at which speed we are getting maximum power.

**Key Words:** Wind-energy; Fuzzy logic control; solar battery system; open winding permanent magnetic machine.

#### 1. INTRODUCTION

Energy is a major input for overall socio-economic development. During next two decades the use of fossil fuels is expected to fuel the economic development process of a majority of the world. However, during the period 2020-2050, fossil fuels price will become higher than any other renewable energy sources because the fossil fuels are almost ready to reach their vanishing level. [5].

Therefore, the renewable energy options are expected to play a vital role in accelerating the development and sustainable growth in the second half of this century, accounting then to 50 to 60% of the total global energy supply.[5] Renewable sources include the sun, water, wind, fuel wood, agricultural residue, and animal dung. Fossil fuels are non-renewable energy sources. Energy from the sun is known as solar energy. Hydel power is derived from water. Biomass – firewood, biodegradable waste, animal dung, and crop residues – become source of energy they are burnt. Among the renewable energy sources wind energy is one of the promising renewable options in India. According to MNRE, India the total installed capability of wind generation is 8574MW. Solar (PV) power is the other promising green energy source and it can be produced without using rotating generators. In reality, solar power and wind power both are complementary up to some extent. Since during the cloudy days and nighttime are with tough winds, in contrast the sunny days are almost calm with the weak winds. Hence a wind-solar hybrid system is able to offer more reliability towards maintaining continuous power supply while compared with the other generation systems.

In practice when the wind - solar –hybrid generation system operates at its rated wind velocity, wind turbine output power will normally exceeds the consumer load side power, so excess energy batteries are required to store this excess energy. The traditional hybrid wind and solar generation system for energy conversion needs separated power electronic converters shunted to transfer power supply. Since the solar and wind energies need two-stage converters with the complex control strategy and make the system structure to be more complex with less efficiency. In general permanent magnetic machines face the difficulty in maintaining voltage regulation with their flux control and due to their limitation towards invariable power speed. In this regard to overcome these difficulties, various control strategies, hybrid excitation-techniques and designs for magnetic circuits are developed in recent literature [3, 5]. However, these schemes are seriously suffered with drawbacks of additional excitation losses and complex – structures, control structures, these suggested methods losses their inherent advantages of high power density and high efficiency.

In this regard, the existed wind and solar generation system suffering from these difficulties and the complex structure and control strategies, this paper presents a novel hybrid wind solar hybrid system equipped with the open-end winding permanent-magnet machine. The proposed Hybrid scheme description is given in the section [2]. The modeling and operational principle and modeling is presented in section 3 followed by the section 4 presents the proposed control structure. Simulation model and result analysis for the proposed system are also presented and discussed in section [5].

Mainly the proposed hybrid scheme is to tracking of maximum power for wind system and regulation of output voltage within the limit of rated wind velocity by adapting the inherent operational characteristics of open-end winding permanent magnet machine [1-4]. For this we have chosen Fuzzy logic control (FLC). The main advantage of FLC is fast response, easier and more efficient. In this method steady state characteristics response is very quick

## 2. HYBRID SCHEME DESCRIPTION

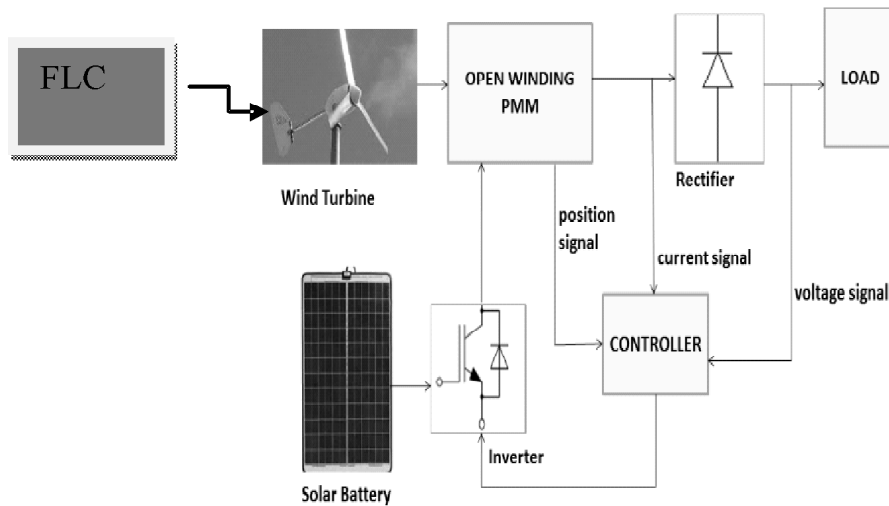

Figure 1: Proposed Hybrid Wind Solar system

Fig. 2.1 shows the proposed hybrid wind solar system with the novel structure equipped with open-end winding permanent magnet machine along MPPT technique Fuzzy logic control. The two open ends of the open winding machine are directly connected one side to rectifier with DC load and the other side to 3-phase inverter with solar batteries. The control signals acquired by the controller from voltage and current signals at the DC

load side, positional signal from the open winding machine rotor. With this type of control structure the inverter is able to track the maxim power from the wind turbine and the output voltage at DC load also can be maintained. To get maximum power we have to obtain optimum speed where the turbine generator system rotates. So we have taken position signal from controller to get optimum speed.

### 3. MODELING AND OPERATIONAL PRINCIPLE

**Wind turbine Modeling:** First and the foremost element of any wind power system is wind turbine. The Wind turbines with the blades designed aerodynamically yields rotating mechanical power by capturing the wind power from atmosphere by means of. Normally wind turbine is designed with three number of blades. A shaft is coupled in between turbine and generator to convert this mechanical energy into electrical energy.

The wind turbine power fundamental equation is given by

$$P_m = 0.5\rho AC_p(\lambda, \beta) V^3 \quad (1)$$

Where,  $\rho$  = density of air (in **kg/m<sup>3</sup>**)

$V$  = wind velocity (in **m/s**)

$A$  = area swept by rotor (in **m<sup>2</sup>**)

$\beta$  = pitch angle

$\lambda$  = tip speed ratio =  $R\omega/V$

$C_p$  = wind power coefficient function

(Function of  $\lambda, \beta$ )

$R$  = radius of turbine (in **m**)

$\omega$  = angular speed (in **rad/s**)

#### Open winding machine modeling:

- In the generation mode, with the existed connection of two open ends of open winding machine has neutral point is opened. And so the proposed structure, phase winding and inverter combination can be approximately considered as a three phase voltage source  $E_a, E_b$  and  $E_c$ , the open winding machine terminal voltages  $e_a, e_b$  and  $e_c$ , and  $V_a, V_b$  and  $V_c$  as rectifier input voltages [5].

- The relationship of voltages of inverter, generator and rectifier in the equivalent can be taken as

$$V_p = E_p + e_p \quad (p = a, b, c - \text{phases})$$

The matrix form of voltage equations can be rewritten as follows:

$$\begin{bmatrix} V_a \\ V_b \\ V_c \end{bmatrix} = \begin{bmatrix} e_a \\ e_b \\ e_c \end{bmatrix} + (R + PLS) \begin{bmatrix} i_a \\ i_b \\ i_c \end{bmatrix} + P \begin{bmatrix} \psi \sin \theta \\ \psi \sin(\theta - 120) \\ \psi \sin(\theta + 120) \end{bmatrix} \quad (2)$$

Where,  $R$ - Per phase resistance of open winding machine

$L_s$ -Per phase inductance of open winding machine

$\theta$  - The rotor angle

With reference to the rotor frame these voltage equations becomes,

$$\begin{bmatrix} V_d \\ V_q \end{bmatrix} = \begin{bmatrix} e_d \\ e_q \end{bmatrix} - \begin{bmatrix} R + LdP & wLq \\ wLd & R + LqP \end{bmatrix} \begin{bmatrix} i_d \\ i_q \end{bmatrix} + \begin{bmatrix} 0 \\ w\psi \end{bmatrix} \quad (3)$$

Where  $V_d$  and  $V_q$  represents the d-axis and q-axis input voltages of the rectifier and  $e_d$  and  $e_q$  are the d-axis and q-axis output voltage of the inverter.

**Operational Principle of Inverter:** As mentioned in the earlier section a three symmetric voltage source  $e_a$ ,  $e_b$  and  $e_c$  can replace the inverter modeling by neglecting voltage with higher order harmonics. And the voltage vector relation can be taken as,

$$V_p = e_p + E_p \quad (p = a, b, c)$$

Based on the above equation it can be noticed that the output voltage magnitude does not depend on the phase angle of the input voltage vector and the operational principle of the inverter is to achieve voltage regulation at input side of the rectifier.

And when the engine with less speed, in order to regulate the DC side load voltage the inverter output voltage must be increased to supply the need of the rectifier input voltage. At this scenario the DC load is supplied by power generated from open-winding machine and the inverter side battery.

Otherwise, when the engine speed is high, the excess power generation from the open-winding machine will feed both the rectifier side DC load and the inverter side battery with the help of control strategies presented in the section 4.

#### 4. PROPOSED CONTROL STRUCTURE

The block diagram of the proposed hybrid scheme in Fig. 2.1 also shows the control structure needed to achieve the objectives of the proposed model discussed earlier. The implementation of control strategies needs detection of corresponding positional signal from open-winding machine and voltage, current signals from the rectifier.

To achieve MPPT from the wind turbine, the control scheme also requires best reference optimum speed of wind turbine  $\omega^*$ . To get this speed reference value Fuzzy logic control method is to be adapted by obtaining the optimum speed. The fuzzy logic control method is followed by “IF-THEN” rule with “AND” operator. Based on this entire MPPT technique was performed. In the Fuzzy Implementation, a mamdani FLC is selected and the inputs of the FLC are error and change in error and output signal is generated according to fuzzy rule “IF-THEN”.

#### 5. SIMULATION MODEL AND RESULT ANALYSIS

The Simulink diagram of the proposed hybrid scheme is along with control algorithms is shown in Fig. 5.1.

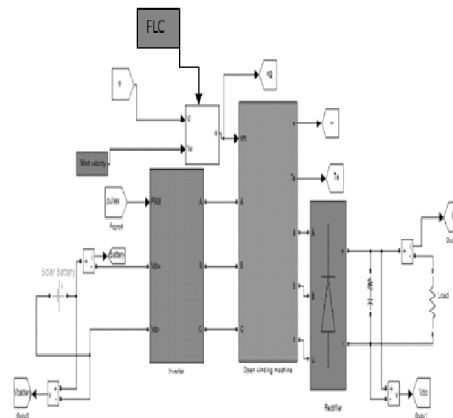

Figure 2: Simulation model of Proposed Hybrid Wind Solar system

The simulation model contains different modules includes wind turbine connected to open winding generator, 3-phase inverter with solar battery, rectifier connected to DC load and the control algorithm.

**Simulation Parameters:** The following table displays the system specifications used during MATLAB simulation.

**Table 1**  
**Simulation Parameters**

<b>Wind Turbine Specifications</b>	
Radius of wind wheel (in m)	0.8
Optimum energy utilization coefficient of wind	0.48
Optimum value of tip speed ratio	0.002
Moment of inertia of wind turbine (in $\text{kg} \cdot \text{m}^2$ )	8
<b>Open-winding Machine Specifications</b>	
Number of Pole - pairs	12
Resistance offered by the stator (in $\Omega$ )	0.1
Inductance offered along direct-axis (in mH)	0.035
Inductance offered along quadrature-axis (in mH)	0.035
Flux from Permanent magnets (in Wb)	0.036
<b>Other Specifications</b>	
Voltage rating of battery (V)	48
DC load side voltage (V)	24
Power rating of Resistive - load (W)	120

**Simulation result analysis:** The developed Simulink model with the parameters shown in Table1 is simulated using optimum tip speed ratio as MPPT method for wind turbine. And the control performances of the model are studied under constant load and at different wind speeds.

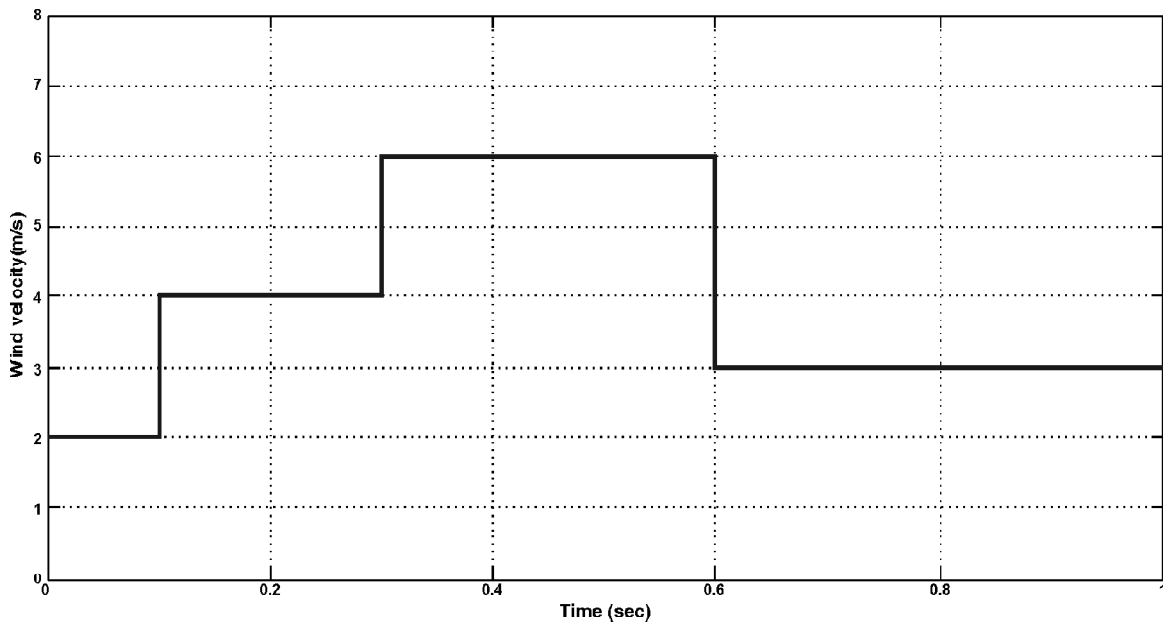

**Figure 3: Simulation wave forms of wind speed at different time intervals**

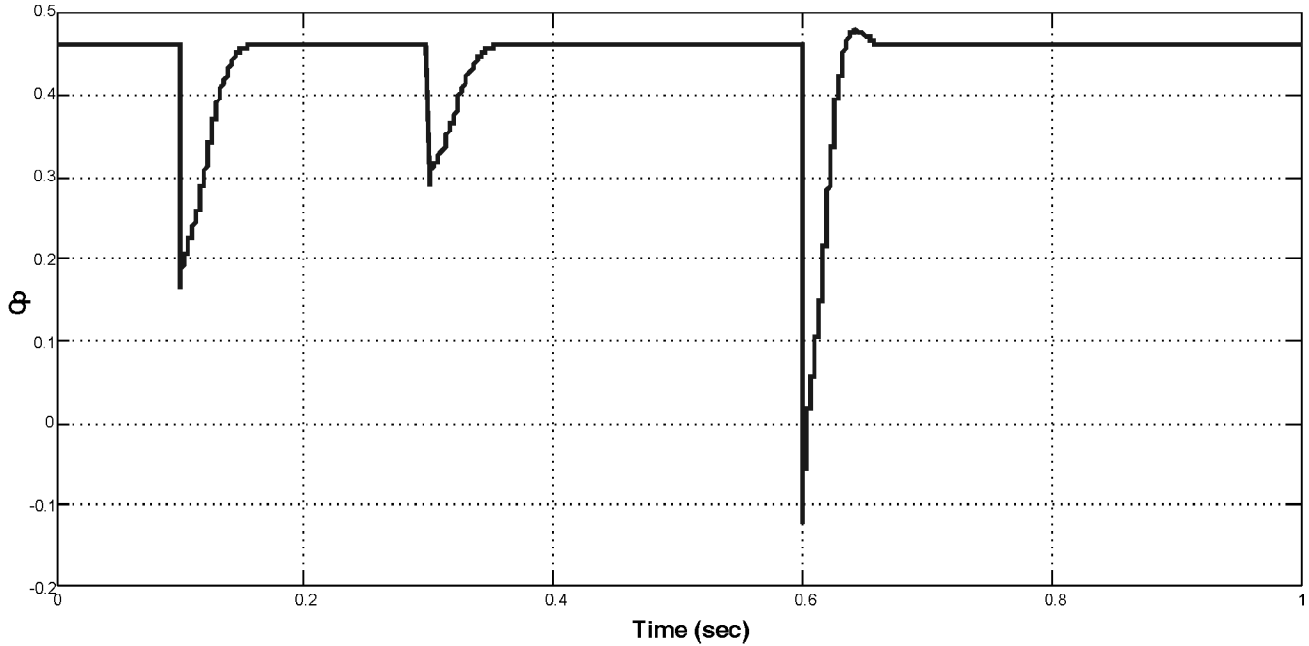

Figure 4: Simulation wave forms of coefficient of wind power ( $C_p$ )

These simulation results give the stable tracking performance of the developed system under extreme conditions. The MPPT control strategy works in order to maintain energy utilization coefficient of wind at its optimum value of 0.48 by adjusting the speed of the wind turbine in accordance with the corresponding changes in wind speed.

Fig.5 shows that the simulation waveform of well stabilized hybrid system with output DC load voltage at 24V in accordance with the aforementioned changes in the wind speed.

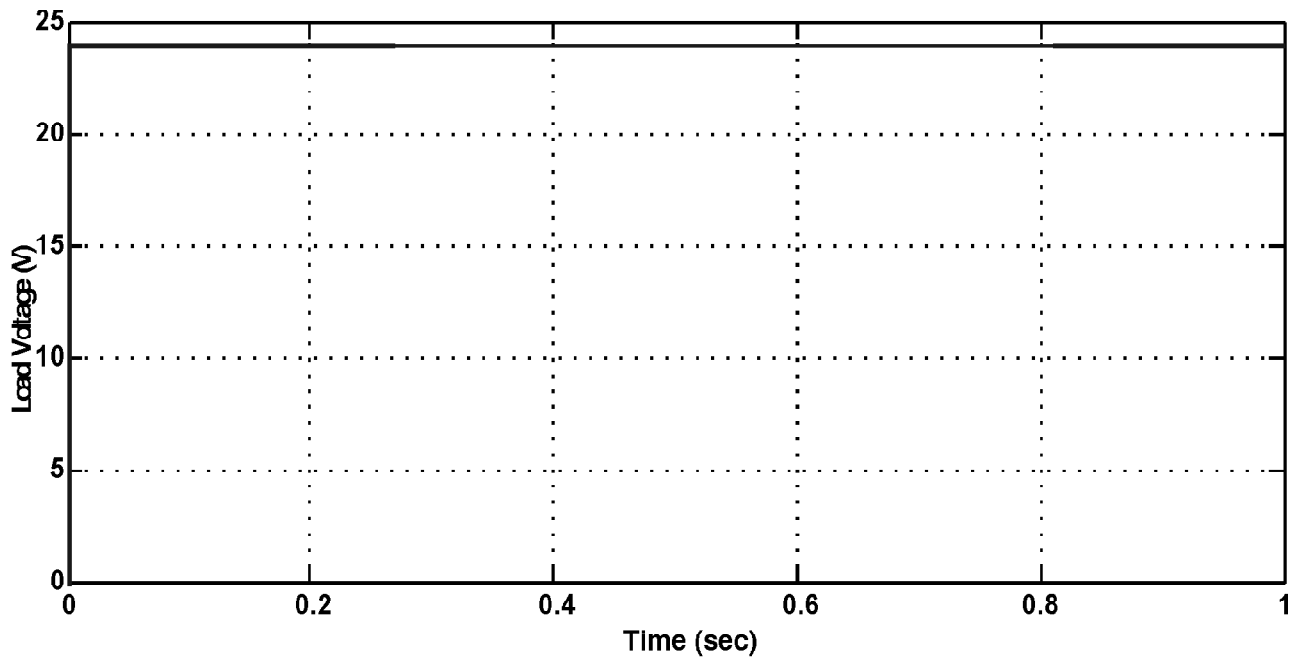

Figure 5: Simulation waveform of DC load voltage

Fig. 6 shows the simulated output power wave forms of solar battery, the wind turbine and the DC load.

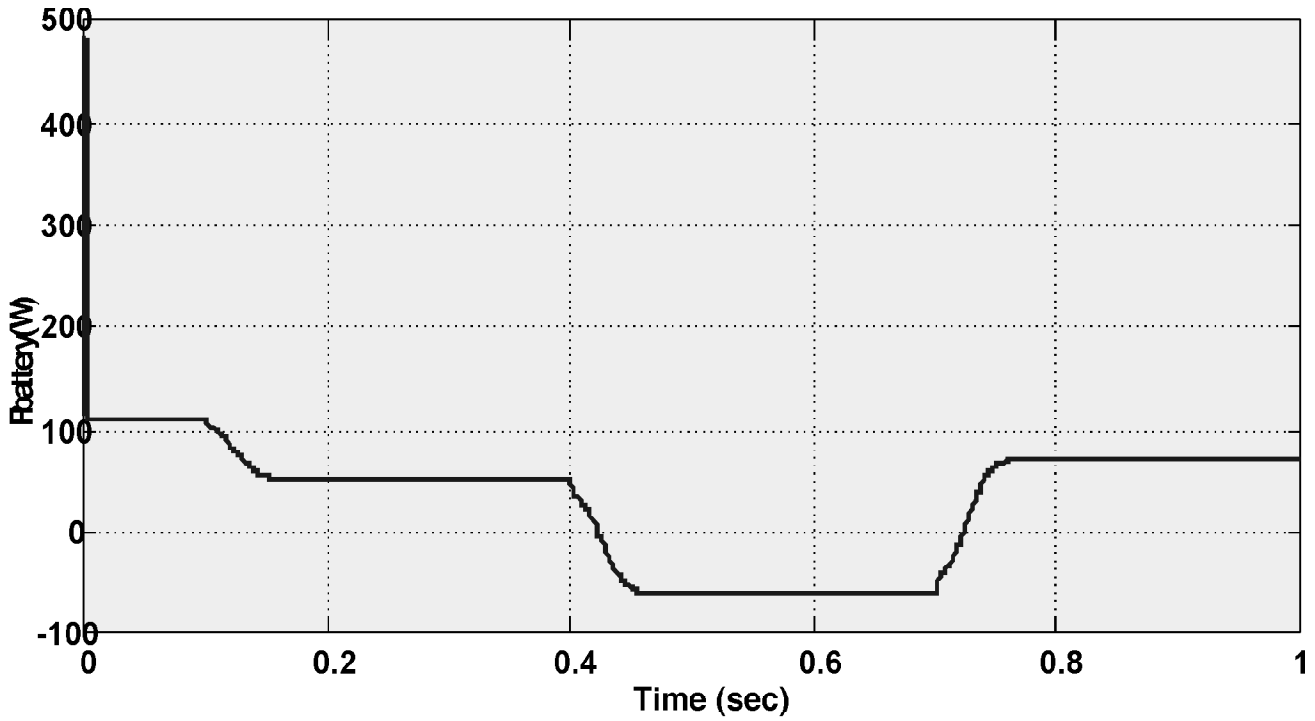

Figure 6 (a): Simulation waveforms of solar battery

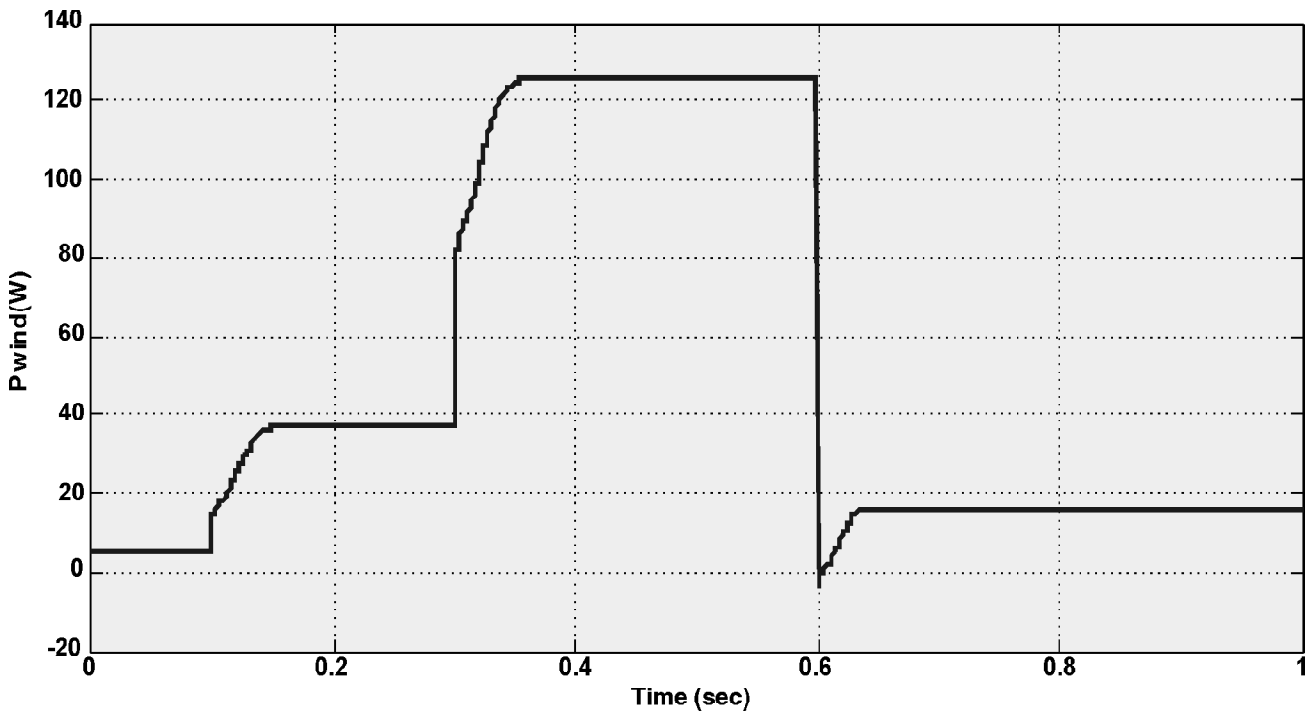

Figure 6 (b): Simulation waveforms of wind power

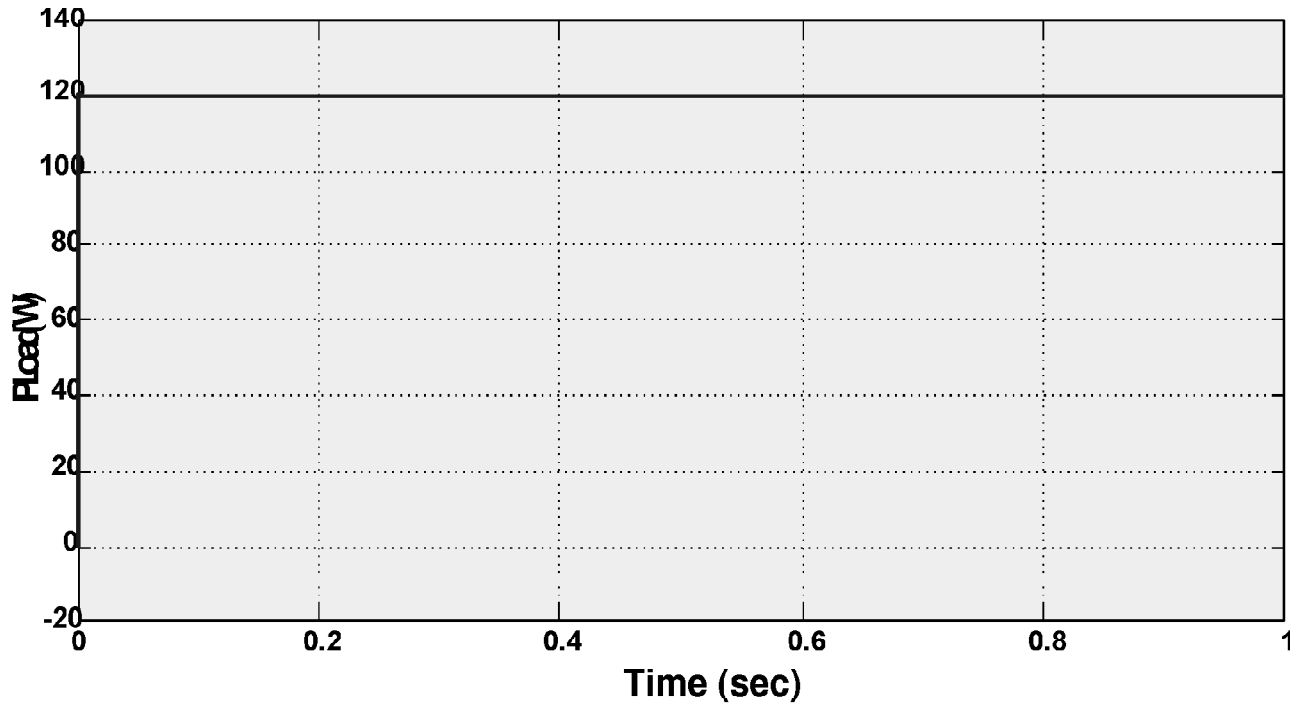

Figure 6 (c): Simulation waveforms of DC load-side power

Combining these waveforms, it can be observed that, whenever the speed of wind increases, more power will be delivered from the wind turbine to the load, accordingly the solar battery will deliver less output power to the load. In contrast whenever the speed of wind decreases, more power will be delivered from the solar battery to the load, accordingly the wind turbine will deliver less power to the load. Here successfully the DC load power is stabilized at 120W because of good complementarily shown by both the wind and solar generation systems.

## 6. CONCLUSION

From the above simulation results of the proposed hybrid wind solar system it can be concluded that the model is able to achieve good stability of load voltage regulation under variable wind speed and constant DC load. The tip speed ratio method is succeeded in tracking maximum wind power by maintaining optimum  $C_p$  value against wind speed change. The simulation results maintain good agreement with the theoretical analysis. And the proposed hybrid scheme can be suitable for multiple generations, and also can be spread over the other power applications.

## REFERENCES

- [1] Mu-Shin Kwak, Seung-Ki Sul, "Control of an Open-Winding Machine in a Grid-Connected Distributed Generation System", IEEE Transaction on Industry Electronics, vol. 44, pp. 1259–1267, July 2008.
- [2] Guo Qingding, Sun Yi-biao Wang Limei, "Modern permanent magnet motor servo system". Beijing: China Electric Power Press, 2006.
- [3] Ahmed G. Abo-Khalil, Dong-Choon Lee, "MPPT Control of Wind Generation Systems Based on Estimated Wind Speed Using SVR", IEEE Transactions on Industrial Electronics, vol. 55, 2008.
- [4] Zeliang Shu, Jian Tang, Yuhua Guo *et al.* "An Efficient SVPWM A. lgorithm With Low Computational Overhead for Three-Phase Inverters", IEEE Transactions on Power Electronics, vol. 22, 2007.



- [5] Chen Liwen, Wei Jiadan, Deng Qingtang, "Simulation research of a novel wind and solar hybrid power system", IEEE conference, 978-1-4577-1600-3/12/\$26.00 © 2012 IEEE.
- [6] Xue Dingyu, Chen Yangquan, "System simulation technology and application based on the MATLAB/Simulink", Beijing: Tsinghua University Press, 2003.
- [7] Peng Zhang, S.S. Williamson. "Recent Status and Future Prospects of Integrated Starter-Generator Based Hybrid Electric Vehicles". Vehicle Power and Propulsion Conference, pp. 1-8, 2008.
- [8] Shuangxia Niu, K.T. Chau, J.Z. Jiang. "A Permanent-Magnet Double-Stator Integrated-Starter-Generator for Vehicles" Vehicle Power and Propulsion Conference, pp. 1-6, 2008.
- [9] Chunhua Liu, K.T. Chau, J.Z. Jiang. "A Permanent-Magnet Hybrid Brushless Integrated-Starter-Generator for Hybrid Electric Vehicles" IEEE Transactions on Industrial Electronics, pp. 1-9, 2010.
- [10] K. Vanitha, Ch. Shravani, International Journal of Engineering Research & Technology (IJERT) Vol. 2 Issue 11, November - 2013.