

Dynamics, Adaptive Backstepping Control and Circuit Implementation of Sprott MO₅ Chaotic System

A. Sambas*, M. Mamat** and M. Sanjaya W.S.***

ABSTRACT

This research work discusses the qualitative properties of Sprott MO₅ chaotic system. The Lyapunov exponents of the Sprott MO₅ chaotic system are obtained as $L_1 = 0.1387$, $L_2 = 0$, and $L_3 = -0.8373$. Since the sum of the Lyapunov exponents is negative, the Sprott MO₅ chaotic system is dissipative. Also, the Kaplan-Yorke dimension of the Sprott MO₅ chaotic system is obtained as $D_{KY} = 2.1657$. The Sprott MO₅ chaotic system have three unstable equilibrium points on the x -axis. The phase portraits of the Sprott MO₅ chaotic system are simulated using MATLAB. Next, an adaptive backstepping controller is designed to stabilize the Sprott MO₅ chaotic system with unknown parameters. MATLAB simulations have been shown to illustrate and validate all the main results derived in this work. An electronic circuit realization of the Sprott MO₅ chaotic system is presented in details. Finally, the circuit experimental results of the Sprott MO₅ chaotic attractor show agreement with the numerical simulations.

Keywords: Chaos, chaotic systems, Sprott MO₅ chaotic system, adaptive control, circuit simulation.

1. INTRODUCTION

Chaotic systems are defined as nonlinear dynamical systems which are very sensitive to initial conditions, topologically mixing and also with dense periodic orbits [1].

The sensitivity to initial conditions of a chaotic system is indicated by a positive Lyapunov exponent. A dissipative chaotic system is characterized by the condition that the sum of the Lyapunov exponents of the chaotic system is negative.

Since Lorenz discovered a 3-D chaotic system of a weather model [2], great interest has been shown in the chaos literature in the analysis and modelling of many 3-D chaotic systems such as Rössler system [3], Rabinovich system [4], ACT system [5], Sprott systems [6], Chen system [7], Lü system [8], Shaw system [9], Feeny system [10], Shimizu system [11], Liu-Chen system [12], Cai system [13], Tigan system [14], Colpitt's oscillator [15], WINDMI system [16], Zhou system [17], etc.

Recently, many 3-D chaotic systems have been discovered such as Li system [18], Elhadj system [19], Pan system [20], Sundarapandian system [21], Yu-Wang system [22], Sundarapandian-Pehlivan system [23], Zhu system [24], Vaidyanathan systems [25-44], Tacha system [45], Vaidyanathan-Madhavan system [46], Pehlivan system [47], Jafari system [48], Pham system [49-50], etc.

Chaos theory has many important applications in science and engineering such as dynamo systems [51-55], Tokamak [56-57], oscillators [58-65], lasers [66], robotics [67], chemical reactors [68-75], biology [76-90], ecology [91], cardiology [92], memristors [93-94], artificial neural networks [95-96], text encryption [97], image encryption [98], voice encryption [99], secure communication systems [100-105], etc.

* Department of Mechanical Engineering, Universitas Muhammadiyah Tasikmalaya, Indonesia

** Faculty of Informatics and Computing, Universiti Sultan Zainal Abidin, Kuala Terengganu, Malaysia

*** Department of Physics, Universitas Islam Negeri Sunan GunungDjati, Bandung, Indonesia

Chaos control and chaos synchronization are important research problems in the chaos theory. In the last three decades, many mathematical methods have been developed successfully to address these research problems.

The study of control of a chaotic system investigates methods for designing feedback control laws that globally or locally asymptotically stabilize or regulate the outputs of a chaotic system.

Many methods have been developed for the control and tracking of chaotic systems such as active control [106-110], adaptive control [111-117], backstepping control [118-120], sliding mode control [121, 122], etc.

The synchronization of chaotic systems has applications in secure communications [123-125], cryptosystems [126-127], encryption [128-130], etc.

In the chaos literature, many different methodologies have been also proposed for the synchronization and anti-synchronization of chaotic systems such as PC method [131], active control [132-142], time-delayed feedback control [143,144], adaptive control [145-156], sampled-data feedback control [157-160], backstepping control [161-170], sliding mode control [171-176], etc.

In Section 2, we discuss the dynamics and qualitative properties of the Sprott MO_5 jerk chaotic system. The Lyapunov exponents of the Sprott MO_5 chaotic system are obtained as $L_1 = 0.1387$, $L_2 = 0$, and $L_3 = -0.8373$. Since the sum of the Lyapunov exponents of the Sprott MO_5 jerk chaotic system is negative, we deduce that the Sprott MO_5 chaotic system is dissipative. Also, the Kaplan-Yorke dimension of the Sprott MO_5 chaotic system is obtained as $D_{KY} = 2.1657$. The Sprott MO_5 chaotic system have three unstable equilibrium points on the x – axis. The phase portraits of the Sprott MO_5 chaotic system are simulated using MATLAB.

In Section 3, an adaptive backstepping controller is designed to stabilize the Sprott MO_5 jerkchaotic system with unknown parameters. MATLAB simulations have been shown to illustrate and validate all the main results derived in this work. In Section 4, an electronic circuit realization of the Sprott MO_5 jerkchaotic system is presented in detail. The circuit experimental results of the Sprott MO_5 jerk chaotic attractor show agreement with the numerical simulations. Finally, Section 5 concludes the paper with a summary.

2. DYNAMICS AND ANALYSIS OF SPROTT MO_5 CHAOTIC SYSTEM

The dynamics of the Sprott MO_5 jerk chaotic system [177] is described as follows.

$$\begin{aligned}\dot{x} &= y \\ \dot{y} &= z \\ \dot{z} &= -az - by + x - x^3\end{aligned}\tag{1}$$

where x, y, z are the states and a, b are positive parameters.

The Sprott MO_5 jerk chaotic system (1) depicts a *chaotic attractor* when the parameter values are taken as follows:

$$a = 0.7, \quad b = 1\tag{2}$$

For numerical simulations, we take the initial conditions of the Sprott MO_5 jerk chaotic system (1) as

$$x(0) = 0, \quad y(0) = 0, \quad z(0) = 0.1\tag{3}$$

The 3-D portrait of the Sprott MO_5 jerk chaotic system (1) for the parameter values (2) and the initial conditions (3) is depicted in Figure 1.

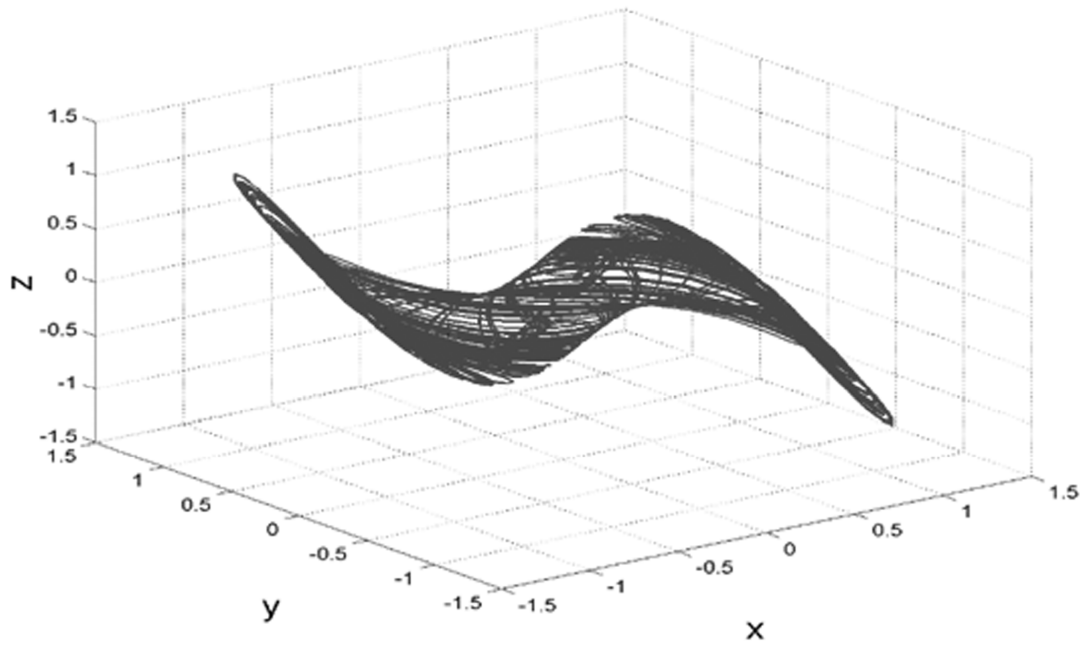

Figure 1: The chaotic attractor of the Sprott MO_5 chaotic system in R^3

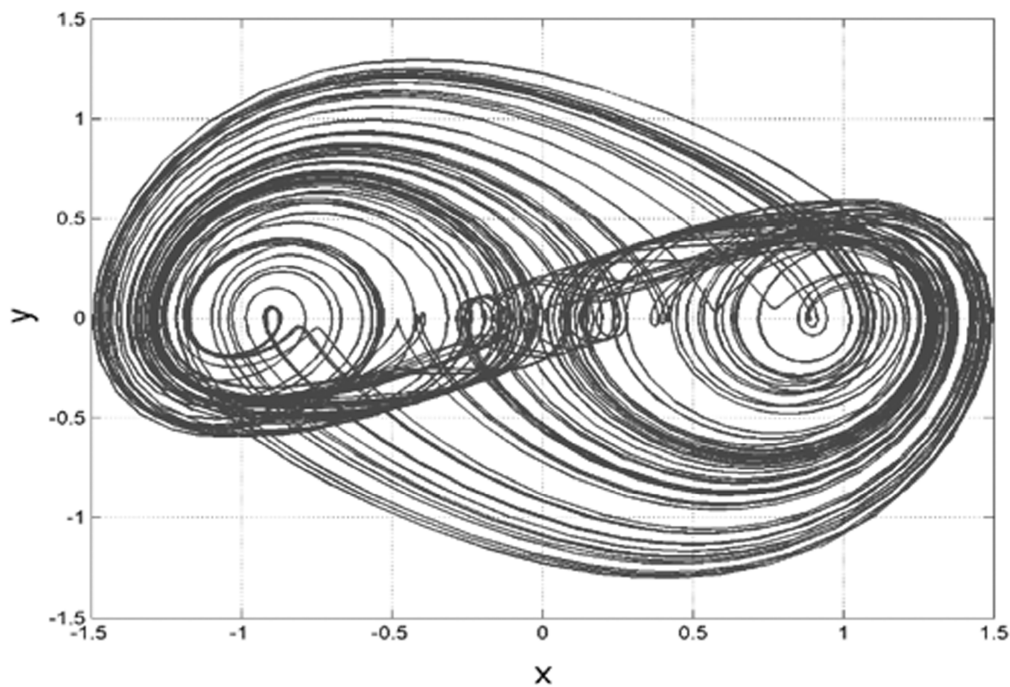

Figure 2: The 2-D projection of the Sprott MO_5 system on (x, y) plane

The 2-D portraits (projections on the three coordinate planes) of the Sprott MO_5 jerk chaotic system (1) are depicted in Figures 2-4.

The equilibrium points of the system (1) are obtained by solving the following system of equations with the parameter values as in the chaotic case (2):

$$\begin{cases} y = 0 \\ z = 0 \\ -az - by + x - x^3 = 0 \end{cases} \quad (4)$$

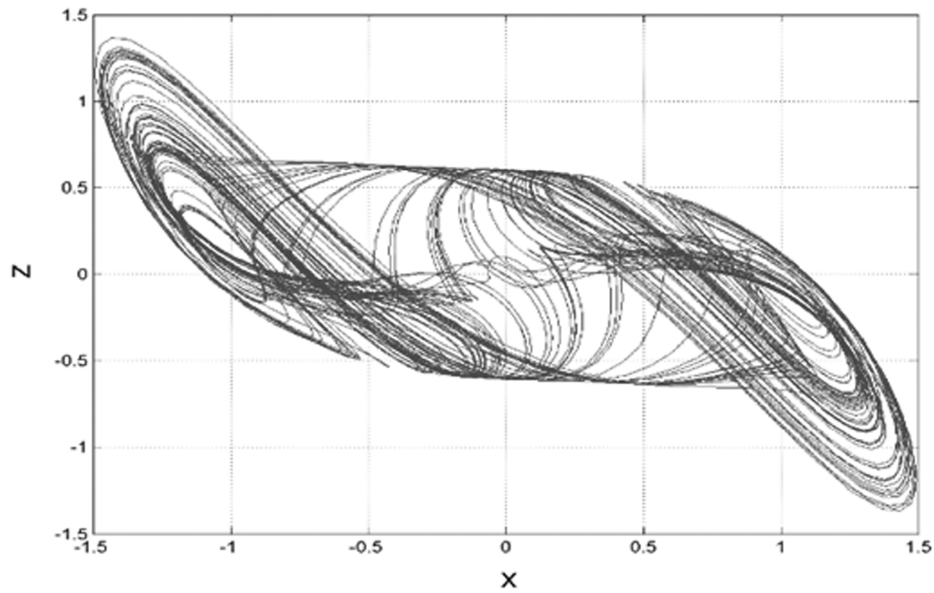

Figure 3: The 2-D projection of the Spratt MO_5 system on (x, z) plane

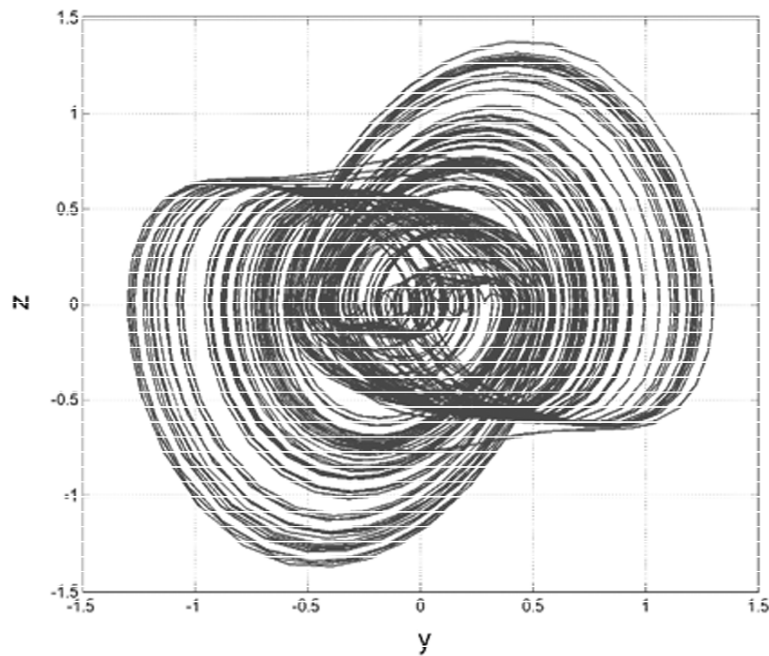

Figure 4: The 2-D projection of the Spratt MO_5 system on (y, z) plane

Solving (4), we obtain three equilibrium points of the Spratt MO_5 chaotic system (1), viz.

$$E_0 = \begin{bmatrix} 0 \\ 0 \\ 0 \end{bmatrix}, \quad E_1 = \begin{bmatrix} 1 \\ 0 \\ 0 \end{bmatrix}, \quad E_2 = \begin{bmatrix} -1 \\ 0 \\ 0 \end{bmatrix} \quad (5)$$

The Jacobian matrix of the system (1) is obtained as

$$J(x, y, z) = \begin{bmatrix} 0 & 1 & 0 \\ 0 & 0 & 1 \\ 1-3x^2 & -1 & -0.7 \end{bmatrix} \quad (6)$$

Thus, the Jacobian matrix of (1) at E_0 is obtained as

$$J(E_0) = \begin{bmatrix} 0 & 1 & 0 \\ 0 & 0 & 1 \\ 1 & -1 & -0.7 \end{bmatrix} \quad (7)$$

which has the eigenvalues

$$\lambda_1 = 0.5762, \quad \lambda_{2,3} = -0.6381 \pm 1.1525 i \quad (8)$$

This shows that the equilibrium E_0 is a saddle-focus.

Next, the Jacobian matrix at E_1 is obtained as

$$J(E_1) = \begin{bmatrix} 0 & 1 & 0 \\ 0 & 0 & 1 \\ -2 & -1 & -0.7 \end{bmatrix} \quad (9)$$

which has the eigenvalues

$$\lambda_1 = -1.2216, \quad \lambda_{2,3} = 0.2608 \pm 1.2527 i \quad (10)$$

This shows that the equilibrium E_1 is a saddle-focus.

Since $J(E_1) = J(E_2)$, it is immediate that the equilibrium E_2 is also a saddle-focus.

Hence, all the three equilibrium points of the Sprott jerk chaotic system (1) are saddle-foci, which are unstable.

For the chosen parameter values (2), the Lyapunov exponents of the system (1) are numerically obtained using MATLAB as:

$$L_1 = 0.1387, \quad L_2 = 0, \quad L_3 = -0.8373 \quad (11)$$

Since the spectrum of Lyapunov exponents (11) has a positive term L_1 the system (1) is chaotic.

Also, the Maximal Lyapunov Exponent (MLE) of the jerk system (1) is calculated as $L_1 = 0.1387$.

Since the sum of the Lyapunov exponents is negative, the system (1) is dissipative.

Also, the Kaplan-Yorke dimension of the chaotic system (1) is calculated as:

$$D_{KY} = 2 + \frac{L_1 + L_2}{|L_3|} = 2.1657, \quad (12)$$

which is fractional.

Figure 5 depicts the Lyapunov exponents of the chaotic system (1).

4. ADAPTIVE CONTROL OF THE SPROTT MO_5 CHAOTIC SYSTEM

In this section, we construct an adaptive controller for globally stabilizing the unstable Sprott MO_5 jerk system with unknown parameters.

We consider the controlled Sprott MO_5 system

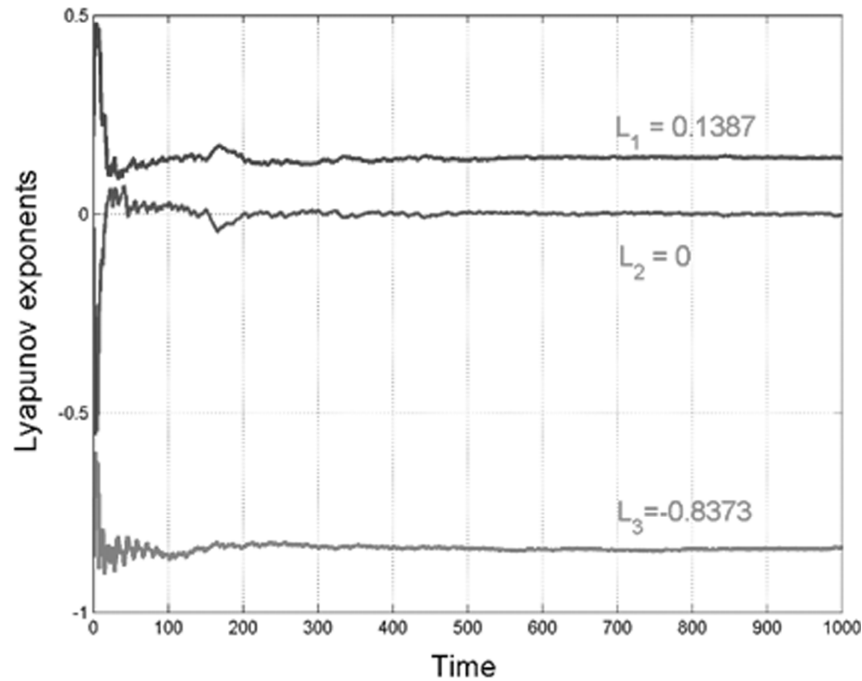

Figure 5: Lyapunov exponents of the Sprott MO_5 jerk chaotic system

$$\begin{aligned}
 \dot{x} &= y \\
 \dot{y} &= z \\
 \dot{z} &= -az - by + x - x^3 + u
 \end{aligned} \tag{13}$$

where x, y, z are state variables, a, b are unknown, constant, parameters and u is the adaptive backstepping control to be designed using estimates $A(t), B(t)$ of the unknown parameters a, b , respectively.

We define the parameter estimation errors as

$$\begin{aligned}
 e_a(t) &= a - A(t) \\
 e_b(t) &= b - B(t)
 \end{aligned} \tag{14}$$

Differentiating (14) with respect to we get

$$\begin{aligned}
 \dot{e}_a &= -\dot{A}(t) \\
 \dot{e}_b &= -\dot{B}(t)
 \end{aligned} \tag{15}$$

Next, we shall state and prove the main result of this section.

Theorem 1. The Sprott MO_5 jerk system (13) with unknown parameters a and b is globally and exponentially stabilized by the adaptive feedback control law

$$u(t) = -4x - [5 - B(t)]y - [3 - A(t)]z + x^3 - k\eta_z \tag{16}$$

where $k > 0$ is a gain constant, with

$$\eta_z = 2x + 2y + z \tag{17}$$

and the update law for the parameter estimates is given by

$$\begin{aligned}
 \dot{A} &= -z\eta_z \\
 \dot{B} &= -y\eta_z
 \end{aligned} \tag{18}$$

Proof. We prove this result via backstepping control method and Lyapunov stability theory [178].

First, we define a quadratic Lyapunov function

$$V_1(\eta_x) = \frac{1}{2}\eta_x^2 \quad (19)$$

where

$$\eta_x = x \quad (20)$$

Differentiating V_1 along the dynamics (13), we obtain

$$\dot{V}_1 = xy = -\eta_x^2 + \eta_x(x+y) \quad (21)$$

Now, we define

$$\eta_y = x + y \quad (22)$$

Using (22), we can simplify (21) as

$$\dot{V}_1 = -\eta_x^2 + \eta_x\eta_y \quad (23)$$

Next, we define a quadratic Lyapunov function

$$V_2(\eta_x, \eta_y) = V_1(\eta_x) + \frac{1}{2}\eta_y^2 = \frac{1}{2}(\eta_x^2 + \eta_y^2) \quad (24)$$

Differentiating V_2 along the dynamics (13), we get

$$\dot{V}_2 = -\eta_x^2 - \eta_y^2 + \eta_y(2x + 2y + z) \quad (25)$$

Now, we define

$$\eta_z = 2x + 2y + z \quad (26)$$

Using (26), we can simplify (25) as

$$\dot{V}_2 = -\eta_x^2 - \eta_y^2 + \eta_y\eta_z \quad (27)$$

Finally, we define a quadratic Lyapunov function

$$V(\eta_x, \eta_y, \eta_z, e_a, e_b) = \frac{1}{2}(\eta_x^2 + \eta_y^2 + \eta_z^2 + e_a^2 + e_b^2) \quad (28)$$

Differentiating V along the dynamics (13), we get

$$\dot{V} = -\eta_x^2 - \eta_y^2 - \eta_z^2 + \eta_z S - e_a \dot{A} - e_b \dot{B} \quad (29)$$

where

$$S = \eta_z + \eta_y + \dot{\eta}_z = \eta_z + \eta_y + 2\dot{x} + 2\dot{y} + \dot{z} \quad (30)$$

Simplifying the equation (30), we get

$$S = 4x + (5-b)y + (3-a)z - x^3 + u \quad (31)$$

Substituting (16) into (31), we get

$$S = -[b - B(t)]y - [a - A(t)]z - k\eta_z \quad (32)$$

Using (14), we can simplify (32) as

$$S = -e_b y - e_a z - k\eta_z \quad (33)$$

Substituting (33) into (29), we get

$$\dot{V} = -\eta_x^2 - \eta_y^2 - (1+k)\eta_z^2 + e_a [-z\eta_z - \dot{A}] + e_b [-y\eta_z - \dot{B}] \quad (34)$$

Substituting (18) into (34), we obtain

$$\dot{V} = -\eta_x^2 - \eta_y^2 - (1+k)\eta_z^2 \quad (35)$$

Thus, it is clear that \dot{V} is a negative semi-definite function on R^3 .

From (35), it follows that $\eta(t) = (\eta_x(t), \eta_y(t), \eta_z(t))$ and the parameter estimation vector $(e_a(t), e_b(t))$ are globally bounded, i.e.

$$[\eta(t) \quad e_a(t) \quad e_b(t)] \in L_\infty \quad (36)$$

Also, it follows from (35) that

$$\dot{V} \leq -\eta_x^2 - \eta_y^2 - \eta_z^2 = -\|\eta(t)\|^2 \quad (37)$$

That is,

$$\|\eta(t)\|^2 \leq -\dot{V} \quad (38)$$

Integrating the inequality (38) from 0 to t , we get

$$\int_0^t \|\eta(\tau)\|^2 d\tau \leq V(0) - V(t) \quad (39)$$

From (39), it follows that $\eta(t) \in L_2$.

Using (13), we can conclude that $\dot{\eta} \in L_\infty$.

Thus, using Barbalat's lemma [178], we conclude that $\eta(t) \rightarrow 0$ exponentially as $t \rightarrow \infty$ for all initial conditions $\eta(0) \in R^3$. Thus, it follows that $x(t) \rightarrow 0$, $y(t) \rightarrow 0$ and $z(t) \rightarrow 0$ exponentially as $t \rightarrow \infty$ for all initial conditions in R^3 .

This completes the proof. ■

For numerical simulations, the parameter values of the Sprott MO_5 system (13) are taken as in the chaotic case, *viz.* $a = 0.7$ and $b = 1$. We take the gain constant as $k = 10$.

The initial conditions of the Sprott MO_5 chaotic system (13) are taken as $x(0) = 8.3$, $y(0) = 6.2$ and $z(0) = -14.5$.

The initial conditions of the parameter estimates are taken as $A(0) = 15.7$ and $B(0) = 5.9$.

Figure 6 describes the time-history of the state vector $(x(t), y(t), z(t))$ of the controlled Sprott MO_5 jerk system (13).

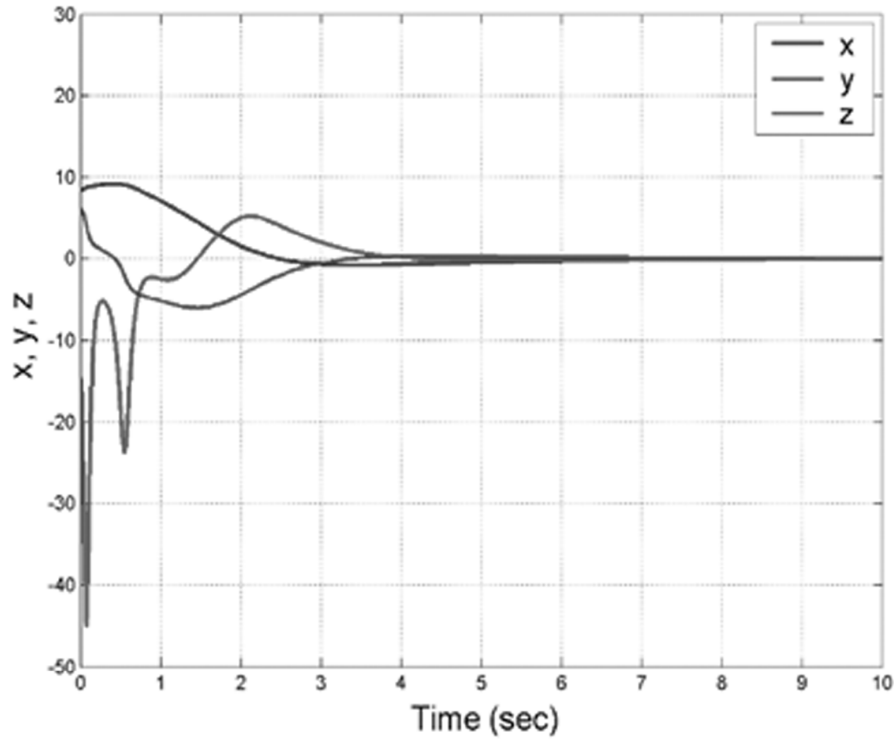

Figure 6: Time-history of the controlled state of the MO_5 system (13)

5. CIRCUIT REALIZATION OF THE SPROTT MO_5 CHAOTIC SYSTEM

In this section, we design an electronic circuit modeling of the Sprott MO_5 jerk chaotic system (1). The circuit in Fig. 11 has been designed following an approach based on operational amplifiers [179-180] where the state variables x , y , z of the system (1) are associated with the voltages across the capacitors C_1 , C_2 and C_3 , respectively. The nonlinear term of system (1) are implemented with the analog multiplier. By applying Kirchhoff's laws to the designed electronic circuit, its nonlinear equations are derived in the following form:

$$\left\{ \begin{array}{l} \dot{x} = \frac{1}{C_1 R_1} y \\ \dot{y} = \frac{1}{C_2 R_2} z \\ \dot{z} = -\frac{1}{C_3 R_3} z - \frac{1}{C_3 R_4} y + \frac{1}{C_3 R_5} x - \frac{1}{100 C_3 R_6} x^3 \end{array} \right. \quad (40)$$

We choose the following:

$$\begin{aligned} R_1 = R_2 = R_4 = R_5 = R_7 = R_8 = 10k\Omega, R_6 = 100k\Omega \\ R_3 = 14.286k\Omega, R_9 = R_{10} = R_{11} = R_{12} = 10k\Omega, \\ C_1 = C_2 = C_3 = 10nF \end{aligned}$$

The circuit has three integrators by using Op-amp TL082CD in a feedback loop and two multipliers IC AD633. The supplies of all active devices are $\pm 15V$.

With MultiSIM 10.0, we obtain the experimental observations of system (1) as shown in Figs. 11-13. As compared with Figs. 2-4, a good qualitative agreement between the numerical simulation and the MultiSIM 10.0 results of the Sprott MO_5 chaotic system is confirmed.

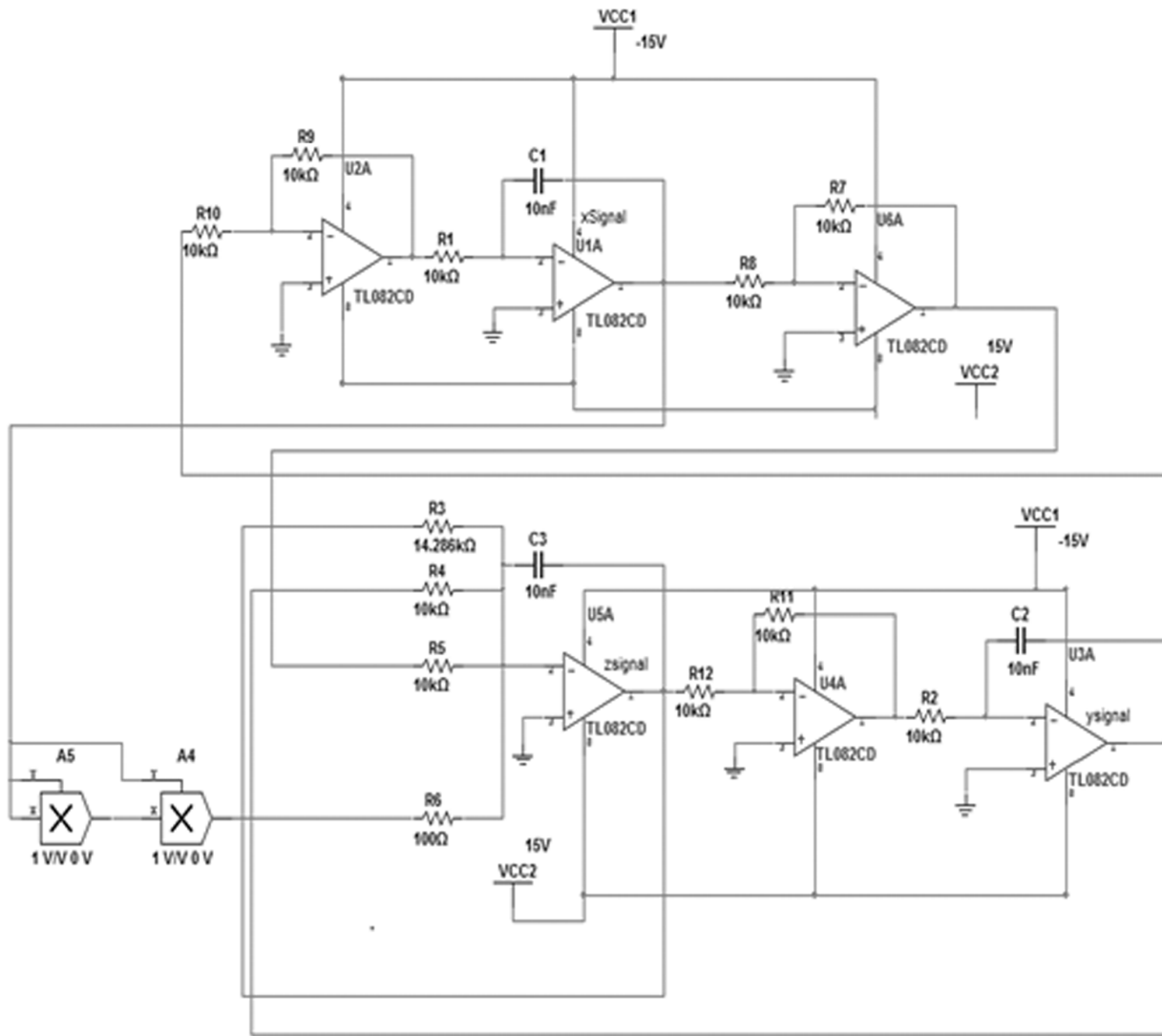

Figure 7: Circuit realization of the Sprott MO_5 chaotic system using MultiSIM 10.0

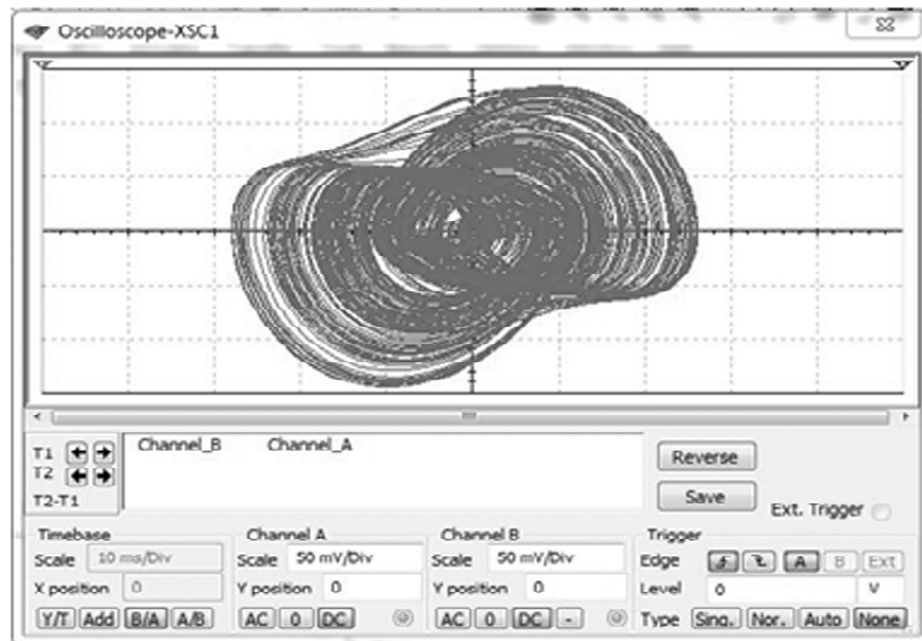

Figure 8: 2-D projection of the Sprott MO_5 chaotic system in x-y plane using MultiSIM 10.0

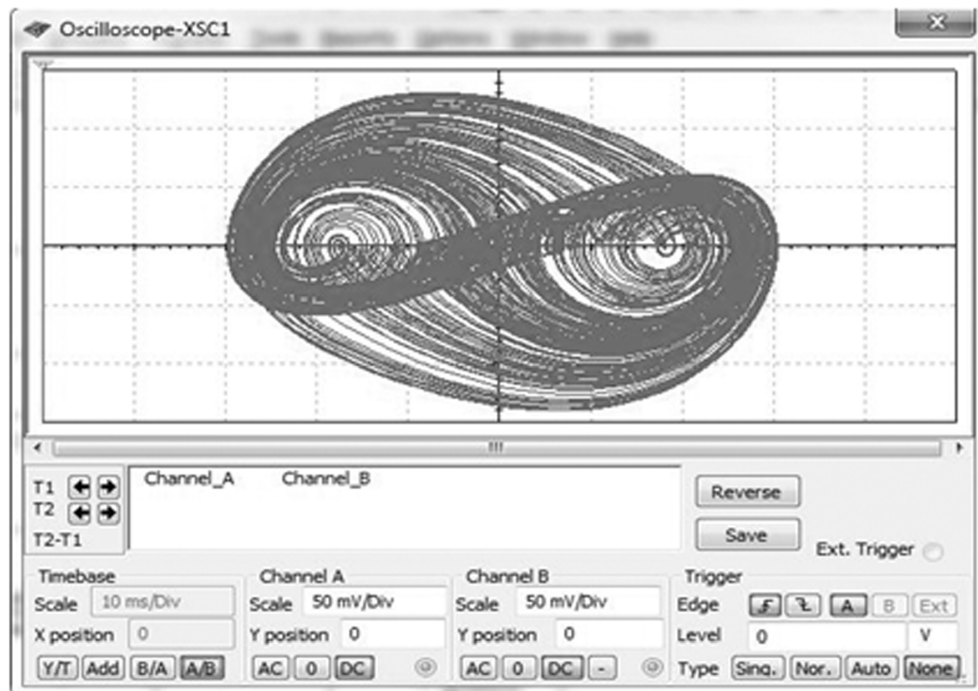

Figure 9: 2-D projection of the Sprott MO_5 chaotic system in y - z plane using MultiSIM 10.0

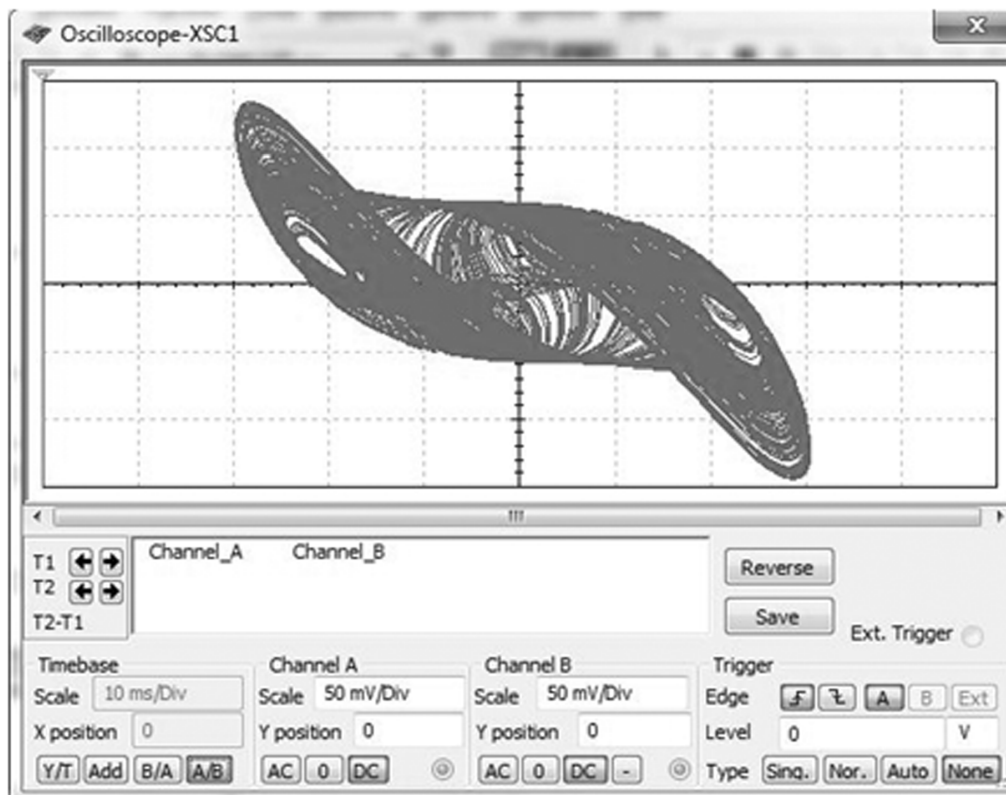

Figure 10: 2-D projection of the Sprott MO_5 chaotic system in x - z plane using MultiSIM 10.0

6. CONCLUSIONS

In this research work, we discussed the qualitative properties of Sprott chaotic system. Using backstepping control, we established new results for the adaptive control of the Sprott chaotic system. An electronic circuit realization of the Sprott chaotic system has been presented in detail that shows agreement of the circuit and numerical simulations for the Sprott chaotic system.

REFERENCES

- [1] S.H. Strogatz, *Nonlinear Dynamics and Chaos: With applications to Physics, Biology, Chemistry, and Engineering*, Perseus Books, Massachusetts, USA, 1994.
- [2] E.N. Lorenz, "Deterministic nonperiodic flow," *Journal of the Atmospheric Sciences*, **20**, 130-141, 1963.
- [3] O.E. Rössler, "An equation for continuous chaos," *Physics Letters A*, **57**, 397-398, 1976.
- [4] M.I. Rabinovich and A.L. Fabrikant, "Stochastic self-modulation of waves in nonequilibrium media," *Sov. Phys. JETP*, **50**, 311-317, 1979.
- [5] A. Arneodo, P. Couillet, and C. Tresser, "Possible new strange attractors with spiral structure," *Communications in Mathematical Physics*, **79**, 573-579, 1981.
- [6] J.C. Sprott, "Some simple chaotic flows," *Physical Review E*, **50**, 647-650, 1994.
- [7] G. Chen and T. Ueta, "Yet another chaotic oscillator," *International Journal of Bifurcation and Chaos*, **9**, 1465-1466, 1999.
- [8] J. Lü and G. Chen, "A new chaotic attractor coined," *International Journal of Bifurcation and Chaos*, **12**, 659-661, 2002.
- [9] R. Shaw, "Strange attractors, chaotic behaviour and information flow," *Zeitschrift für Naturforschung*, **36**, 80-112, 1981.
- [10] B. Feeny and F.C. Moon, "Chaos in a forced dry-friction oscillator: Experiments and numerical modeling," *Journal of Sound and Vibration*, **170**, 303-323, 1994.
- [11] T. Shimizu and N. Moroika, "On the bifurcation of a symmetric limit cycle to an asymmetric one in a simple model," *Physics Letters A*, **76**, 201-204, 1980.
- [12] W. Liu and G. Chen, "A new chaotic system and its generation," *International Journal of Bifurcation and Chaos*, **13**, 261-267, 2003.
- [13] G. Cai and Z. Tan, "Chaos synchronization of a new chaotic system via nonlinear control," *Journal of Uncertain Systems*, **1**, 235-240, 2007.
- [14] G. Tigan and D. Opris, "Analysis of a 3D chaotic system," *Chaos, Solitons and Fractals*, **36**, 1315-1319, 2008.
- [15] G.P. Kennedy, "Chaos in the Colpitts oscillator," *IEEE Transactions on Circuits and Systems-I*, **41**, 771-774, 1994.
- [16] J. Wang, D. Lu and L. Tian, "Global synchronization for time delay of WINDMI system," *Chaos, Solitons and Fractals*, **30**, 629-635, 2006.
- [17] W. Zhou, Y. Xu, H. Lu, and L. Pan, "On dynamics analysis of a new chaotic attractor," *Physics Letters A*, **372**, 5773-5777, 2008.
- [18] D. Li, "A three-scroll chaotic attractor," *Physics Letters A*, **372**, 387-393, 2008.
- [19] Z. Elhadj, "Dynamical analysis of a 3-D chaotic system with only two quadratic nonlinearities," *Journal of Systems Science and Complexity*, **21**, 67-75, 2008.
- [20] L. Pan, D. Xu and W. Zhou, "Controlling a novel chaotic attractor using linear feedback," *Journal of Information and Computing Science*, **5**, 117-124, 2010.
- [21] V. Sundarapandian, "Analysis and anti-synchronization of a novel chaotic system via active and adaptive controllers," *Journal of Engineering Science and Technology Review*, **6**, 45-52, 2013.
- [22] F. Yu, C. Wang, Q. Wan, and Y. Hu, "Complete switched modified function projective synchronization of a five-term chaotic system with uncertain parameters and disturbances," *Pramana*, **80**, 223-235, 2013.
- [23] V. Sundarapandian and I. Pehlivan, "Analysis, control, synchronization and circuit design of a novel chaotic system," *Mathematical and Computer Modelling*, **55**, 1904-1915, 2012.
- [24] C. Zhu, Y. Liu, and Y. Guo, "Theoretical and numerical study of a new chaotic system," *Intelligent Information Management*, **2**, 104-109, 2010.
- [25] S. Vaidyanathan, "A new six-term 3-D chaotic system with an exponential nonlinearity," *Far East Journal of Mathematical Sciences*, **79**, 135-143, 2013.
- [26] S. Vaidyanathan, "Analysis and adaptive synchronization of two novel chaotic systems with hyperbolic sinusoidal and cosinusoidal nonlinearity and unknown parameters," *Journal of Engineering Science and Technology Review*, **6**, 53-65, 2013.
- [27] S. Vaidyanathan, "A new eight-term 3-D polynomial chaotic system with three quadratic nonlinearities," *Far East Journal of Mathematical Sciences*, **84**, 219-226, 2014.
- [28] S. Vaidyanathan, "Analysis, control and synchronization of a six-term novel chaotic system with three quadratic nonlinearities," *International Journal of Modelling, Identification and Control*, **22**, 41-53, 2014.

- [29] S. Vaidyanathan, "Analysis and adaptive synchronization of eight-term 3-D polynomial chaotic systems with three quadratic nonlinearities," *European Physical Journal: Special Topics*, **223**, 1519-1529, 2014.
- [30] S. Vaidyanathan, Ch. Volos, V.T. Pham, K. Madhavan, and B.A. Idowu, "Adaptive backstepping control, synchronization and circuit simulation of a 3-D novel jerk chaotic system with two hyperbolic sinusoidal nonlinearities," *Archives of Control Sciences*, **24** (3), 257-285, 2014.
- [31] S. Vaidyanathan, "Analysis, control, and synchronization of a 3-D novel jerk chaotic system with two quadratic nonlinearities," *Kyungpook Mathematical Journal*, **55** (3), 563-586, 2015.
- [32] S. Vaidyanathan and C. Volos, "Analysis and adaptive control of a novel 3-D conservative no-equilibrium chaotic system," *Archives of Control Sciences*, **25** (3), 333-353, 2015.
- [33] S. Vaidyanathan, "A novel chemical chaotic reactor system and its output regulation via integral sliding mode control," *International Journal of ChemTech Research*, **8** (11), 669-683, 2015.
- [34] S. Vaidyanathan, "Integral sliding mode control design for the global chaos synchronization of identical novel chemical chaotic reactor systems," *International Journal of ChemTech Research*, **8** (11), 684-699, (2015).
- [35] S. Vaidyanathan, "Global chaos synchronization of novel coupled Van der Pol conservative chaotic systems via adaptive control method," *International Journal of PharmTech Research*, **8** (8), 95-111, 2015.
- [36] S. Vaidyanathan, C.K. Volos, and V.-T. Pham, "Global chaos control of a novel nine-term chaotic system via sliding mode control," *Studies in Computational Intelligence*, **576**, 571-590, 2015.
- [37] S. Vaidyanathan, "Adaptive control design for the anti-synchronization of novel 3-D chemical chaotic reactor systems," *International Journal of ChemTech Research*, **8** (11), 654-668, 2015.
- [38] S. Vaidyanathan, "A novel chemical chaotic reactor system and its adaptive control," *International Journal of ChemTech Research*, **8** (7), 146-158, 2015.
- [39] S. Vaidyanathan, "Adaptive synchronization of novel 3-D chemical chaotic reactor systems," *International Journal of ChemTech Research*, **8** (7), 159-171, 2015.
- [40] S. Vaidyanathan, Analysis, properties and control of an eight-term 3-D chaotic system with an exponential nonlinearity, *International Journal of Modelling, Identification and Control*, **23** (2), 164-172, 2015.
- [41] S. Vaidyanathan, "A novel coupled Van der Pol conservative chaotic system and its adaptive control," *International Journal of PharmTech Research*, **8** (8), 79-94, 2015.
- [42] S. Vaidyanathan, K. Rajagopal, C.K. Volos, I.M. Kyprianidis and I.N. Stouboulos, Analysis, adaptive control and synchronization of a seven-term novel 3-D chaotic system with three quadratic nonlinearities and its digital implementation in LabVIEW, *Journal of Engineering Science and Technology Review*, **8** (2), 130-141, 2015.
- [43] S. Vaidyanathan, C.K. Volos and V.-T. Pham, "Analysis, adaptive control and adaptive synchronization of a nine-term novel 3-D chaotic system with four quadratic nonlinearities and its circuit simulation," *Journal of Engineering Science and Technology Review*, **8** (2), 181-191, 2015.
- [44] S. Vaidyanathan and S. Pakiriswamy, A 3-D novel conservative chaotic system and its generalized projective synchronization via adaptive control, *Journal of Engineering Science and Technology Review*, **8** (2), 52-60, 2015.
- [45] O.I. Tacha, C.K. Volos, I.M. Kyprianidis, I.N. Stouboulos, S. Vaidyanathan, and V.-T. Pham, Analysis, adaptive control and circuit simulation of a novel nonlinear finance system, *Applied Mathematics and Computation*, vol. 276, pp. 200-217 (2016).
- [46] S. Vaidyanathan and K. Madhavan, Analysis, adaptive control and synchronization of a seven-term novel 3-D chaotic system, *International Journal of Control Theory and Applications*, vol. 6, pp. 121-137 (2013).
- [47] I. Pehlivan, I.M. Moroz, and S. Vaidyanathan, Analysis, synchronization and circuit design of a novel butterfly attractor, *Journal of Sound and Vibration*, vol. 333, pp. 5077-5096 (2014).
- [48] S. Jafari and J.C. Sprott, Simple chaotic flows with a line equilibrium, *Chaos, Solitons and Fractals*, vol. 57, pp. 79-84 (2013).
- [49] V.T. Pham, C. Volos, S. Jafari, Z. Wei and X. Wang, Constructing a novel no-equilibrium chaotic system, *International Journal of Bifurcation and Chaos*, vol. 24, 1450073 (2014).
- [50] V.T. Pham, S. Vaidyanathan, C.K. Volos and S. Jafari, Hidden attractors in a chaotic system with an exponential nonlinear term, *European Physical Journal: Special Topics*, vol. 224 (8), pp. 1507-1517 (2015).
- [51] S. Vaidyanathan, C.K. Volos and V.-T. Pham, Analysis, control, synchronization and SPICE implementation of a novel 4-D hyperchaotic Rikitake dynamo system without equilibrium, *Journal of Engineering Science and Technology Review*, vol. 8 (2), pp. 232-244 (2015).
- [52] S. Vaidyanathan, V.-T. Pham and C.K. Volos, A 5-D hyperchaotic Rikitake dynamo system with hidden attractors, *European Physical Journal: Special Topics*, vol. 224 (8), pp. 1575-1592 (2015).

- [53] S. Vaidyanathan, Adaptive control of Rikitake two-disk dynamo system, *International Journal of ChemTech Research*, vol. 8 (8), pp. 121-133 (2015).
- [54] S. Vaidyanathan, Hybrid chaos synchronization of Rikitake two-disk dynamo chaotic systems via adaptive control method, *International Journal of ChemTech Research*, vol. 8 (11), pp. 12-15 (2015).
- [55] S. Vaidyanathan, State regulation of Rikitake two-disk dynamo chaotic system via adaptive control method, *International Journal of ChemTech Research*, vol. 8 (9), pp. 374-386 (2015).
- [56] S. Vaidyanathan, Synchronization of Tokamak systems with symmetric and magnetically confined plasma via adaptive control, *International Journal of ChemTech Research*, vol. 8 (6), pp. 818-827 (2015).
- [57] S. Vaidyanathan, Dynamics and control of Tokamak system with symmetric and magnetically confined plasma, *International Journal of ChemTech Research*, vol. 8 (6), pp. 795-803 (2015).
- [58] S. Vaidyanathan, Anti-synchronization of Mathieu-Van der Pol chaotic systems via adaptive control method, *International Journal of ChemTech Research*, vol. 8 (11), pp. 638-653 (2015).
- [59] S. Vaidyanathan, Global chaos synchronization of the forced Van der Pol-chaotic oscillators via adaptive control method, *International Journal of PharmTech Research*, vol. 8 (6), pp. 156-166 (2015).
- [60] S. Vaidyanathan, Sliding controller design for the global chaos synchronization of forced Van der Pol chaotic oscillators, *International Journal of PharmTech Research*, vol. 8 (7), pp. 100-111 (2015).
- [61] S. Vaidyanathan, Output regulation of the forced Van der Pol chaotic oscillator via adaptive control method, *International Journal of PharmTech Research*, vol. 8 (6), pp. 106-116 (2015).
- [62] S. Vaidyanathan, Global chaos synchronization of Mathieu-Van der Pol chaotic systems via adaptive control method, *International Journal of ChemTech Research*, vol. 8 (10), pp. 148-162 (2015).
- [63] S. Vaidyanathan, Global chaos control of Mathieu-Van der Pol system via adaptive control method, *International Journal of ChemTech Research*, vol. 8 (9), pp. 406-417 (2015).
- [64] S. Vaidyanathan, Global chaos synchronization of Duffing double-well chaotic oscillators via integral sliding mode control, *International Journal of ChemTech Research*, vol. 8 (11), pp. 141-151 (2015).
- [65] C.K. Volos, V.-T. Pham, S. Vaidyanathan, I.M. Kyrianiadis and I.N. Stouboulos, Synchronization phenomena in coupled Colpitts circuits, *Journal of Engineering Science and Technology Review*, vol. 8 (2), pp. 142-151 (2015).
- [66] S. Donati and S.K. Hwang, Chaos and high-level dynamics in coupled lasers and their applications, *Progress in Quantum Electronics*, vol. 36, pp. 293-341 (2012).
- [67] M. Islam and K. Murase, Chaotic dynamics of a behavior-based miniature mobile robot: effects of environment and control structure, *Neural Networks*, vol. 18, pp. 123-144 (2005).
- [68] S. Vaidyanathan, Sliding mode control of Rucklidge chaotic system for nonlinear double convection, *International Journal of ChemTech Research*, vol. 8 (8), pp. 25-35 (2015).
- [69] S. Vaidyanathan, Anti-synchronization of Brusselator chemical reaction systems via adaptive control, *International Journal of ChemTech Research*, vol. 8 (6), pp. 759-768 (2015).
- [70] S. Vaidyanathan, Adaptive synchronization of chemical chaotic reactors, *International Journal of ChemTech Research*, vol. 8 (2), pp. 612-621 (2015).
- [71] S. Vaidyanathan, Anti-synchronization of Brusselator chemical reaction systems via integral sliding mode control, *International Journal of ChemTech Research*, vol. 8 (11), pp. 700-713 (2015).
- [72] S. Vaidyanathan, Global chaos synchronization of chemical chaotic reactors via novel sliding mode control method, *International Journal of ChemTech Research*, vol. 8 (7), pp. 209-221 (2015).
- [73] S. Vaidyanathan, Adaptive control of a chemical chaotic reactor, *International Journal of PharmTech Research*, vol. 8 (3), pp. 377-382 (2015).
- [74] S. Vaidyanathan, Dynamics and control of Brusselator chemical reaction, *International Journal of ChemTech Research*, vol. 8 (6), pp. 740-749 (2015).
- [75] S. Vaidyanathan, Anti-synchronization of chemical chaotic reactors via adaptive control method, *International Journal of ChemTech Research*, vol. 8 (8), pp. 73-85 (2015).
- [76] S. Vaidyanathan, 3-cells cellular neural network (CNN) attractor and its adaptive biological control, *International Journal of PharmTech Research*, vol. 8 (4), pp. 632-640 (2015).
- [77] S. Vaidyanathan, "Adaptive chaotic synchronization of enzymes-substrates system with ferroelectric behaviour in brain waves," *International Journal of PharmTech Research*, **8** (5), 964-973, 2015.
- [78] S. Vaidyanathan, "Chaos in neurons and synchronization of Birkhoff-Shaw strange chaotic attractors via adaptive control," *International Journal of PharmTech Research*, **8** (6), 1-11, 2015.

- [79] S. Vaidyanathan, "Hybrid chaos synchronization of 3-cells cellular neural network attractors via adaptive control method," *International Journal of PharmTech Research*, **8** (8), 61-73, 2015.
- [80] S. Vaidyanathan, "Adaptive synchronization of generalized Lotka-Volterra three-species biological systems," *International Journal of PharmTech Research*, **8** (5), 928-937, 2015.
- [81] S. Vaidyanathan, "Synchronization of 3-cells cellular neural network (CNN) attractors via adaptive control method," *International Journal of PharmTech Research*, **8** (5), 946-955, 2015.
- [82] S. Vaidyanathan, "Global chaos control of 3-cells cellular neural network attractor via integral sliding mode control," *International Journal of PharmTech Research*, **8** (8), 211-221, 2015.
- [83] S. Vaidyanathan, "Global chaos synchronization of 3-cells cellular neural network attractors via integral sliding mode control," *International Journal of PharmTech Research*, **8** (8), 118-130, 2015.
- [84] S. Vaidyanathan, "Adaptive biological control of generalized Lotka-Volterra three-species biological system," *International Journal of PharmTech Research*, **8** (4), 622-631, 2015.
- [85] S. Vaidyanathan, "Active control design for the hybrid chaos synchronization of Lotka-Volterra biological systems with four competitive species," *International Journal of PharmTech Research*, **8** (8), 30-42, 2015.
- [86] S. Vaidyanathan, "Hybrid chaos synchronization of the FitzHugh-Nagumo chaotic neuron models via adaptive control method," *International Journal of PharmTech Research*, **8** (8), 48-60, 2015.
- [87] S. Vaidyanathan, "Adaptive backstepping control of enzymes-substrates system with ferroelectric behaviour in brain waves," *International Journal of PharmTech Research*, **8** (2), 256-261, 2015.
- [88] S. Vaidyanathan, "Anti-synchronization of 3-cells cellular neural network attractors via adaptive control method," *International Journal of PharmTech Research*, **8** (7), 26-38, 2015.
- [89] S. Vaidyanathan, "Global chaos synchronization of the Lotka-Volterra biological systems with four competitive species via active control," *International Journal of PharmTech Research*, **8** (6), 206-217, 2015.
- [90] S. Vaidyanathan, "Sliding controller design for the global chaos synchronization of enzymes-substrates systems," *International Journal of PharmTech Research*, **8** (7), 89-99, 2015.
- [91] B. Sahoo and S. Poria, "The chaos and control of a food chain model supplying additional food to top-predator," *Chaos, Solitons and Fractals*, **58**, 52-64, 2014.
- [92] T.A. Denton, G.A. Diamond, R.H. Helfant, S. Khan, and H. Karagueuzian, "Fascinating rhythm: A primer on chaos theory and its applications to cardiology," *American Heart Journal*, **120**, 1419-1440, 1990.
- [93] C.K. Volos, I.M. Kyprianidis, I.N. Stouboulos, E. Tlelo-Cuautle and S. Vaidyanathan, "Memristor: A new concept in synchronization of coupled neuromorphic circuits," *Journal of Engineering Science and Technology Review*, **8** (2), 157-173, 2015.
- [94] V.-T. Pham, C.K. Volos, S. Vaidyanathan, T.P. Le and V.Y. Vu, "A memristor-based hyperchaotic system with hidden attractors: Dynamics, synchronization and circuital emulating," *Journal of Engineering Science and Technology*, **8** (2), 205-214, 2015.
- [95] G. He, Z. Cao, P. Zhu, and H. Ogura, "Controlling chaos in a chaotic neural network," *Neural Networks*, **16**, 1195-1200, 2003.
- [96] E. Kaslik and S. Sivasundaram, "Nonlinear dynamics and chaos in fractional-order neural networks," *Neural Networks*, **32**, 245-256, 2012.
- [97] C.K. Volos, I.M. Kyprianidis and I.N. Stouboulos, "Text encryption scheme realized with a chaotic pseudo-random bit generator," *Journal of Engineering Science and Technology Review*, **6**, 9-14, 2013.
- [98] A.S. Andreatos and A.P. Leros, "Secure image encryption based on a Chua chaotic noise generator," *Journal of Engineering Science and Technology Review*, **6**, 90-103, 2013.
- [99] M. Abdulkareem and I.Q. Abduljaleel, "Speech encryption using chaotic map and Blowsh algorithms," *Journal of Basrah Researches*, **39**, 68-76, 2013.
- [100] A. Sambas, M. Sanjaya W.S. and Halimatussadiyah, "Unidirectional chaotic synchronization of Rossler circuit and its application for secure communication," *WSEAS Transactions on Systems*, **9** (11), 506-515, 2012.
- [101] A. Sambas, M. Sanjaya W.S., M. Mamat, N.V. Karadimas and O. Tacha, "Numerical simulations in jerk circuit and its application in a secure communication system," *Proceedings of the WSEAS 17th International Conference on Communications Rhodes Island, Greece*, 190-196, 2013.
- [102] A. Sambas, M. Sanjaya W.S., M. Mamat and O. Tacha, "Design and numerical simulation of unidirectional chaotic synchronization and its application in secure communication system," *Journal of Engineering Science and Technology Review*, **6** (4), 66-73, 2013.

- [103] A. Sambas, M. Sanjaya W.S. and M. Mamat, "Bidirectional coupling scheme of chaotic systems and its application in secure communication system," *Journal of Engineering Science and Technology Review*, **8** (2), 89-95, 2015.
- [104] A. Sambas, M. Sanjaya W.S., M. Mamat, Z. Salleh and F.S. Mohamad, "Secure communications based on the synchronization of the new Lorenz-like attractor circuit," *Advanced Studies in Theoretical Physics*, **9** (8), 379-394, 2015.
- [105] B. Naderi and H. Kheiri, "Exponential synchronization of chaotic system and application in secure communication," *Optik*, **127** (5), 2407-2412, 2016.
- [106] V. Sundarapandian, "Output regulation of the Lorenz attractor," *Far East Journal of Mathematical Sciences*, **42**, 289-299, 2010.
- [107] C.A. Kitio Kwiimy and B.R. Nana Nbandjo, "Active control of horseshoes chaos in a driven Rayleigh oscillator with fractional order deflection," *Physics Letters A*, **375** (39), 3442-3449, 2011.
- [108] S. Vaidyanathan, "Output regulation of Arneodo-Coulet chaotic system," *Communications in Computer and Information Science*, **131**, 585-593, 2011.
- [109] S. Vaidyanathan, "Output regulation of the unified chaotic system," *Communications in Computer and Information Science*, **198**, 1-9, 2011.
- [110] S. Vaidyanathan, "Output regulation of the Liu chaotic system," *Applied Mechanics and Materials*, **110-116**, 3982-3989, 2012.
- [111] G. Chen, "A simple adaptive feedback control method for chaos and hyper-chaos control," *Applied Mathematics and Computation*, **217**, 7258-7264, 2011.
- [112] J. Zheng, "A simple universal adaptive feedback controller for chaos and hyperchaos control," *Computers & Mathematics with Applications*, **61**, 2000-2004, 2011.
- [113] S. Vaidyanathan, "Adaptive controller and synchronizer design for the Qi-Chen chaotic system," *Lecture Notes of the Institute for Computer Sciences, Social-Informatics and Telecommunications Engineering*, **85**, 124-133, 2012.
- [114] V. Sundarapandian, "Adaptive control and synchronization design for the Lu-Xiao chaotic system," *Lecture Notes in Electrical Engineering*, **131**, 319-327, 2013.
- [115] S. Vaidyanathan, "A ten-term novel 4-D hyperchaotic system with three quadratic nonlinearities and its control," *International Journal of Control Theory and Applications*, **6**, 97-109, 2013.
- [116] S. Vaidyanathan, "Analysis, control and synchronization of hyperchaotic Zhou system via adaptive control," *Advances in Intelligent Systems and Computing*, **177**, 1-10, 2013.
- [117] D. Yang and J. Zhou, "Connections among several chaos feedback control approaches and chaotic vibration control of mechanical systems," *Communications in Nonlinear Science and Numerical Simulation*, **19**, 3954-3968, 2014.
- [118] M.T. Yassen, "Chaos control of chaotic dynamical systems using backstepping design," *Chaos, Solitons and Fractals*, **27**, 537-548, 2006.
- [119] J.A. Laoye, U.E. Vincent, and S.O. Kareem, "Chaos control of 4D chaotic systems using recursive backstepping nonlinear controller," *Chaos, Solitons and Fractals*, **39**, 356-362, 2009.
- [120] D. Lin, X. Wang, F. Nian, and Y. Zhang, "Dynamic fuzzy neural networks modeling and adaptive backstepping tracking control of uncertain chaotic systems," *Neurocomputing*, **73**, 2873-2881, 2010.
- [121] S. Vaidyanathan, "Sliding mode control based global chaos control of Liu-Liu-Liu-Su chaotic system," *International Journal of Control Theory and Applications*, **5**, 15-20, 2012.
- [122] S. Vaidyanathan, "Global chaos control of hyperchaotic Liu system via sliding mode control," *International Journal of Control Theory and Applications*, **5**, 117-123, 2012.
- [123] L. Kocarev and U. Parlitz, "General approach for chaos synchronization with applications to communications," *Physical Review Letters*, **74**, 5028-5030, 1995.
- [124] K. Murali and M. Lakshmanan, "Secure communication using a compound signal using sampled-data feedback," *Applied Mathematics and Mechanics*, **11**, 1309-1315, 1995.
- [125] M. Feki, "An adaptive chaos synchronization scheme applied to secure communication," *Chaos, Solitons and Fractals*, **18**, 141-148, 2003.
- [126] J. Yang and F. Zhu, "Synchronization for chaotic systems and chaos-based secure communications via both reduced-order and step-by-step sliding mode observers," *Communications in Nonlinear Science and Numerical Simulation*, **18**, 926-937, 2013.
- [127] L. Kocarev, "Chaos-based cryptography: a brief overview," *IEEE Circuits and Systems*, **1**, 6-21, 2001.
- [128] H. Gao, Y. Zhang, S. Liang and D. Li, "A new chaotic algorithm for image encryption," *Chaos, Solitons and Fractals*, **29**, 393-399, 2006.

- [129] Y. Wang, K.W. Wang, X. Liao and G. Chen, "A new chaos-based fast image encryption," *Applied Soft Computing*, **11**, 514-522, 2011.
- [130] Y. Xu, H. Wang, Y. Li and B. Pei, "Image encryption based on synchronization of fractional chaotic systems," *Communications in Nonlinear Science and Numerical Simulation*, **19**(10), pp. 3735-3744, (2014).
- [131] L.M. Pecora and T.L. Carroll, "Synchronization in chaotic systems," *Physical Review Letters*, **64** (8), pp. 821-825 (1990).
- [132] S. Vaidyanathan and S. Rasappan, "New results on the global chaos synchronization for Liu-Chen-Liu and Lü chaotic systems," *Communications in Computer and Information Science*, **102**, 20-27, 2010.
- [133] S. Vaidyanathan and S. Rasappan, "Hybrid synchronization of hyperchaotic Qi and Lü systems by nonlinear control," *Communications in Computer and Information Science*, **131**, 585-593, 2011.
- [134] S. Vaidyanathan and K. Rajagopal, "Anti-synchronization of Li and T chaotic systems by active nonlinear control," *Communications in Computer and Information Science*, **198**, 175-184, 2011.
- [135] S. Vaidyanathan and S. Rasappan, "Global chaos synchronization of hyperchaotic Bao and Xu systems by active nonlinear control," *Communications in Computer and Information Science*, **198**, 10-17, 2011.
- [136] S. Vaidyanathan and K. Rajagopal, "Global chaos synchronization of hyperchaotic Pang and Wang systems by active nonlinear control," *Communications in Computer and Information Science*, **204**, 84-93, 2011.
- [137] S. Vaidyanathan, "Hybrid chaos synchronization of Liu and Lü systems by active nonlinear control," *Communications in Computer and Information Science*, **204**, 1-10, 2011.
- [138] P. Sarasu and V. Sundarapandian, "Active controller design for generalized projective synchronization of four-scroll chaotic systems," *International Journal of Systems Signal Control and Engineering Application*, **4**, 26-33, 2011.
- [139] S. Vaidyanathan and K. Rajagopal, "Hybrid synchronization of hyperchaotic Wang-Chen and hyperchaotic Lorenz systems by active non-linear control," *International Journal of Systems Signal Control and Engineering Application*, **4**, 55-61, 2011.
- [140] S. Pakiriswamy and S. Vaidyanathan, "Generalized projective synchronization of three-scroll chaotic systems via active control," *Lecture Notes of the Institute for Computer Sciences, Social-Informatics and Telecommunications Engineering*, **85**, 146-155, 2012.
- [141] V. Sundarapandian and R. Karthikeyan, "Hybrid synchronization of hyperchaotic Lorenz and hyperchaotic Chen systems via active control," *Journal of Engineering and Applied Sciences*, **7**, 254-264, 2012.
- [142] R. Karthikeyan and V. Sundarapandian, "Hybrid chaos synchronization of four-scroll systems via active control," *Journal of Electrical Engineering*, **65**, 97-103, 2014.
- [143] E.M. Shahverdiev and K.A. Shore, "Impact of modulated multiple optical feedback time delays on laser diode chaos synchronization," *Optics Communications*, **282**, 3568-3572, 2009.
- [144] T. Botmart, P. Niamsup, and X. Liu, "Synchronization of non-autonomous chaotic systems with time-varying delay via delayed feedback control," *Communications in Nonlinear Science and Numerical Simulation*, **17**, 1894-1907, 2012.
- [145] S. Bowong, "Adaptive synchronization between two different chaotic dynamical systems," *Communications in Nonlinear Science and Numerical Simulation*, **12**, 976-985, 2007.
- [146] W. Lin, "Adaptive chaos control and synchronization in only locally Lipschitz systems," *Physics Letters A*, **372**, 3195-3200, 2008.
- [147] H. Salarieh and A. Alasty, "Adaptive chaos synchronization in Chua's systems with noisy parameters," *Mathematics and Computers in Simulation*, **79**, 233-241, 2008.
- [148] H. Salarieh and A. Alasty, "Adaptive synchronization of two chaotic systems with stochastic unknown parameters," *Communications in Nonlinear Science and Numerical Simulation*, **14**, 508-519, 2009.
- [149] S. Vaidyanathan and K. Rajagopal, "Global chaos synchronization of Lü and Pan systems by adaptive nonlinear control," *Communications in Computer and Information Science*, **205**, 193-202, 2011.
- [150] V. Sundarapandian and R. Karthikeyan, "Anti-synchronization of Lü and Pan chaotic systems by adaptive nonlinear control," *European Journal of Scientific Research*, **64**, 94-106, 2011.
- [151] V. Sundarapandian and R. Karthikeyan, "Anti-synchronization of hyperchaotic Lorenz and hyperchaotic Chen systems by adaptive control," *International Journal of Systems Signal Control and Engineering Application*, **4**, 18-25, 2011.
- [152] V. Sundarapandian and R. Karthikeyan, "Adaptive anti-synchronization of uncertain Tigan and Li systems," *Journal of Engineering and Applied Sciences*, **7**, 45-52, 2012.
- [153] P. Sarasu and V. Sundarapandian, "Generalized projective synchronization of three-scroll chaotic systems via adaptive control," *European Journal of Scientific Research*, **72**, 504-522, 2012.
- [154] P. Sarasu and V. Sundarapandian, "Generalized projective synchronization of two-scroll systems via adaptive control," *International Journal of Soft Computing*, **7**, 146-156, 2012.

- [155] P. Sarasu and V. Sundarapandian, "Adaptive controller design for the generalized projective synchronization of 4-scroll systems," *International Journal of Systems Signal Control and Engineering Application*, **5**, 21-30, 2012.
- [156] S. Vaidyanathan and K. Rajagopal, "Global chaos synchronization of hyperchaotic Pang and hyperchaotic Wang systems via adaptive control," *International Journal of Soft Computing*, **7**, 28-37, 2012.
- [157] S.H. Lee, V. Kapila, M. Porfiri, and A. Panda, "Master-slave synchronization of continuously and intermittently coupled sampled-data chaotic oscillators," *Communications in Nonlinear Science and Numerical Simulation*, **15**, 4100-4113, 2010.
- [158] X.Z. Jin and J.H. Park, "Adaptive synchronization for a class of faulty and sampling coupled networks with its circuit implement," *Journal of the Franklin Institute*, **351**, 4317-4333, 2014.
- [159] C.K. Zhang, L. Jiang, Y. He, Q.H. Wu and M. Wu, "Asymptotical synchronization for chaotic Lur'e systems using sampled-data control," *Communications in Nonlinear Science and Numerical Simulation*, **18**, 2743-2751, 2013.
- [160] X. Xiao, L. Zhou, and Z. Zhang, "Synchronization of chaotic Lur'e systems with quantized sampled-data controller," *Communications in Nonlinear Science and Numerical Simulation*, **19**, 2039-2047, 2014.
- [161] S. Rasappan and S. Vaidyanathan, "Global chaos synchronization of WINDMI and Coulet chaotic systems by backstepping control," *Far East Journal of Mathematical Sciences*, **67**, 265-287, 2012.
- [162] S. Rasappan and S. Vaidyanathan, "Synchronization of hyperchaotic Liu system via backstepping control with recursive feedback," *Communications in Computer and Information Science*, **305**, 212-221, 2012.
- [163] S. Rasappan and S. Vaidyanathan, "Hybrid synchronization of n-scroll Chua and Lur'e chaotic systems via backstepping control with novel feedback," *Archives of Control Sciences*, **22**, 343-365, 2012.
- [164] R. Suresh and V. Sundarapandian, "Global chaos synchronization of a family of n-scroll hyperchaotic Chua circuits using backstepping control with recursive feedback," *Far East Journal of Mathematical Sciences*, **73**, 73-95, 2013.
- [165] S. Rasappan and S. Vaidyanathan, "Hybrid synchronization of n-scroll chaotic Chua circuits using adaptive backstepping control design with recursive feedback," *Malaysian Journal of Mathematical Sciences*, **7**, 219-246, 2013.
- [166] S. Vaidyanathan and S. Rasappan, "Global chaos synchronization of n-scroll Chua circuit and Lur'e system using backstepping control design with recursive feedback," *Arabian Journal for Science and Engineering*, **39**, 3351-3364, 2014.
- [167] S. Rasappan and S. Vaidyanathan, "Global chaos synchronization of WINDMI and Coulet chaotic systems using adaptive backstepping control design," *Kyungpook Mathematical Journal*, **54**, 293-320, 2014.
- [168] S. Vaidyanathan, C.K. Volos, K. Rajagopal, I.M. Kyprianidis and I.N. Stouboulos, "Adaptive backstepping controller design for the anti-synchronization of identical WINDMI chaotic systems with unknown parameters and its SPICE implementation," *Journal of Engineering Science and Technology Review*, **8** (2), 74-82, 2015.
- [169] S. Vaidyanathan, C. Volos, V.-T. Pham and K. Madhavan, "Analysis, adaptive control and synchronization of a novel 4-D hyperchaotic hyperjerker system and its SPICE implementation," *Archives of Control Sciences*, **25** (1), 135-158, 2015.
- [170] S. Vaidyanathan, "Qualitative analysis and control of an eleven-term novel 4-D hyperchaotic system with two quadratic nonlinearities," *International Journal of Control Theory and Applications*, **7** (1), 35-47, 2014.
- [171] H.T. Yau, "Chaos synchronization of two uncertain chaotic nonlinear gyros using fuzzy sliding mode control," *Mechanical Systems and Signal Processing*, **22**, 408-418, 2008.
- [172] H. Li, X. Liao, C. Li, and C. Li, "Chaos control and synchronization via a novel chatter free sliding mode control strategy," *Neurocomputing*, **74**, 3212-3222, 2012.
- [173] S. Vaidyanathan and S. Sampath, "Global chaos synchronization of hyperchaotic Lorenz systems by sliding mode control," *Communications in Computer and Information Science*, **205**, 156-164, 2011.
- [174] V. Sundarapandian and S. Sivaperumal, "Sliding controller design of hybrid synchronization of four-wing chaotic systems," *International Journal of Soft Computing*, **6**, 224-231, 2011.
- [175] S. Vaidyanathan and S. Sampath, "Anti-synchronization of four-wing chaotic systems via sliding mode control," *International Journal of Automation and Computing*, **9**, 274-279, 2012.
- [176] S. Vaidyanathan, S. Sampath and A. T. Azar, "Global chaos synchronization of identical chaotic systems via novel sliding mode control method and its application to Zhu system," *International Journal of Modelling, Identification and Control*, **23** (1), 92-100, 2015.
- [177] J.C. Sprott, *Elegant Chaos*, World Scientific, Singapore, 2010.
- [178] H.K. Khalil, *Nonlinear Systems*, 3rd ed., Prentice Hall, New Jersey, USA, 2002.
- [179] X.F. Li, Y.D. Chu, J.G. Zhang and X. Chang, "Nonlinear dynamics and circuit implementation for a new Lorenz-like attractor," *Chaos, Solitons and Fractals*, **41**, 2360-2370, 2009.
- [180] C. Li, I. Pehlivan, J.C. Sprott and A. Akgul, "A novel four-wing strange attractor born in bistability," *IEICE Electronics Express*, **12** (4), 1-12, 2015.