



International Journal of Control Theory and Applications

ISSN : 0974-5572

© International Science Press

Volume 9 • Number 48 • 2016

Smart Textile System for Human Activity Recognition

Karnati Tulasi¹, S Sivaji² and Ketankumar Vadodaria³

¹ Department of Electronics and communication engineering, VFSTR University, India, E-mail: Tulasikarnati22@gmail.com

² SITRA, Medical Textile - COE

Abstract: Providing precise and opportune information on people's activities is one of the most important tasks in pervasive computing. Automatic recognition of physical activities – commonly referred to as human activity recognition (HAR). This is an active research area with the main purpose of extracting knowledge from the data acquired by pervasive sensors. Especially, the recognition of human activities has become an intensified task within the field, predominantly for medical, military, and security applications. For instance, patients with diabetes, obesity, or heart disease are often required to follow a well-defined exercise routine as part of their treatment. Therefore, recognizing activities such as sitting, walking, running, or cycling becomes useful to furnish feedback to the caretaker regarding the patient's behavior. Similarly, patients with insanity and mental pathologies could be supervised to detect abnormal activities and there by undesirable consequences. Key features involved in HAR are level of acceptability, performance recognition, flexibility, consumption of energy, visibility. The design is an implementation of wearable data acquisition system with e-Textile technology. Wearable sensors are used to monitor person's behavior along with its environment. Data from the e-Textile sensors is processed in the Matlab using neural networks and to be able to extract a set of behavior patterns.

Keywords: HAR, wearable sensors, data acquisition, neural network, e-Textile.

1. INTRODUCTION

In recent time, activity recognition of human from smart and wearable technology has drawn attention because of its growing need in various real life environments, such as healthcare, security surveillance, child care, entertainment and gaming, academic institutions etc. Smart Textiles refers to a broad field of studies and products that extend the functionality³ and usefulness of common fabrics. The convergence of electronics and textiles (e-textiles) can be applicable for the development⁶ of smart materials that can be capable of accomplishing a broad spectrum of functions, found in rigid and non-flexible electronic products nowadays. A wearable, as the word itself expresses, is a device worn on the human body that incorporates the intelligence⁵(sensors and electronics) into the clothes.

Activity recognition based on new wearable technologies is one the important challenges. Recognizing and monitoring human activities are fundamental functions to provide healthcare⁴ and assistance services to elderly people living alone, physically or mentally disabled people, and children. These populations need continuous monitoring of their activities to detect abnormal situations or prevent unpredictable events such as falls.

Wearable technology that used in this design was Lilypad Technology (flexible electronics), integrated directly into the textiles. E-Textile sensors provide accurate and precise information about the person’s behavior³ and conditions. In our design the wearable system was simple to handle and flexible too.

2. STRUCTURE OF HAR SYSTEM

Activity recognition with wearable technology can be defined as the ability to extract high level information about human actions and complex real world situations. Many authors introduced general HAR system structure⁷ with normal electronic devices which are inflexible. This design contains new type of wearable technology using Lilypad Arduino. Each Lilypad was creatively designed⁵ to have large connecting pads to allow them to be sewn into clothing. Lilypad technology does not need soldering of electronic components it involves sewing of e-textiles with conductive threads provide a flexible structure with lot of comfort.

Wearable sensors are attached to the human body to measure attributes of interest such as motion, temperature, light, physiological signals. The sensors should communicate with an integrated device which can be a PC or a customized embedded system. Figure 1 illustrates the data acquisition system of human activity recognition³ which has a wearable part, three Lilypad type e-textile sensors, and Lilypad Arduino microcontroller module, and a communication module which consist in a Lilypad XBee module with a Trace Antenna module integrated.

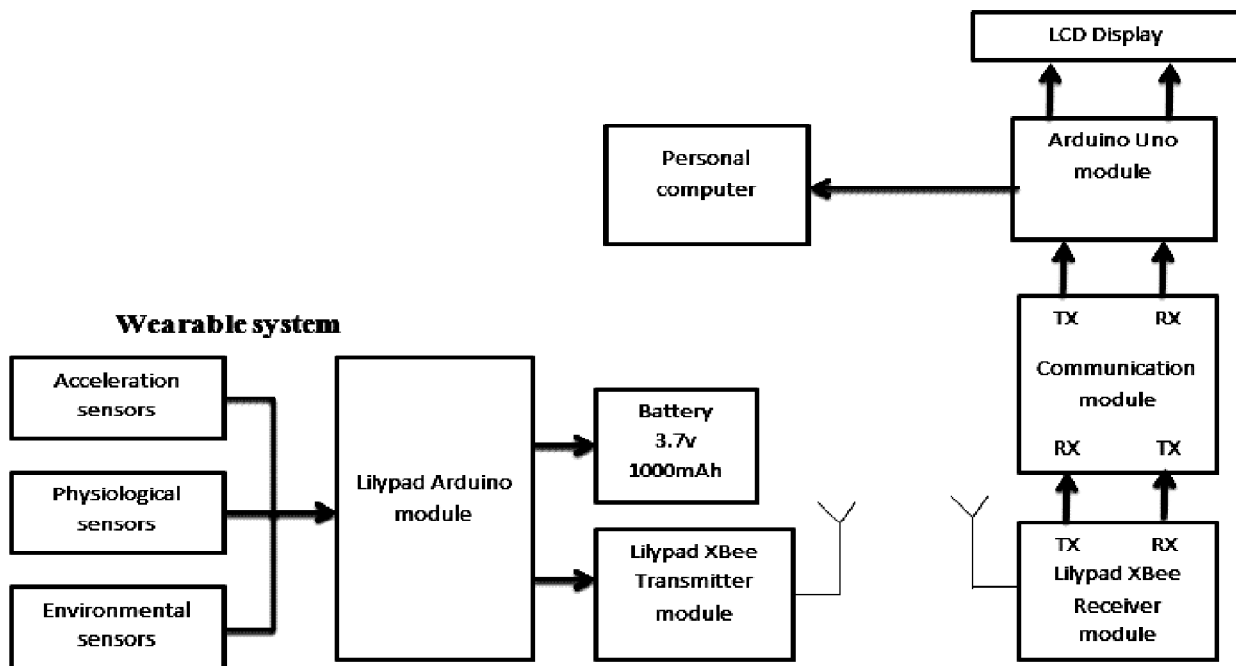

Figure 1: Data acquisition system for Human activity recognition

Lilypad Arduino is the perfect controller for e-textiles and wearables. The Lilypad Arduino board is a microcontroller based on the ATmega32u4. It can be sewn to fabric and to sensors, actuators and power supplies with conductive thread. A micro USB cable is used to attach this board directly to computer.

For receiving data, on the other part of the system, we have an Arduino communication module with an XBee module attached, and an Arduino Uno platform connected to a PC through serial port. For training and testing of human activities these data files are transferred to a PC, and data is processed in the Matlab.

3. DESIGN ISSUES

For early detection of abnormal conditions and supervisory there is a need to design and develop smart wearable device to be used for continuous monitoring of different human activities for twenty four hours and seven days a week. Several design issues included in human activity recognition are:

3.1. Selection of sensors and attributes

Most of the measured attributes are related to the user's movement (accelerometer), environmental variables (temperature, light and humidity), and physiological signals (heart rate and respiration rate) are represented in figure 2. Human activities are so diverse that there does not exist one single type of sensor that could recognize² all of them. For example, physical motion such as standing, sitting, walking can be well-recognized by acceleration sensors. For better performance we can add environment and physiological sensors along with inertial sensors. These wearable sensors are more robust, easier to use, less obtrusive, washable, and even attractive.

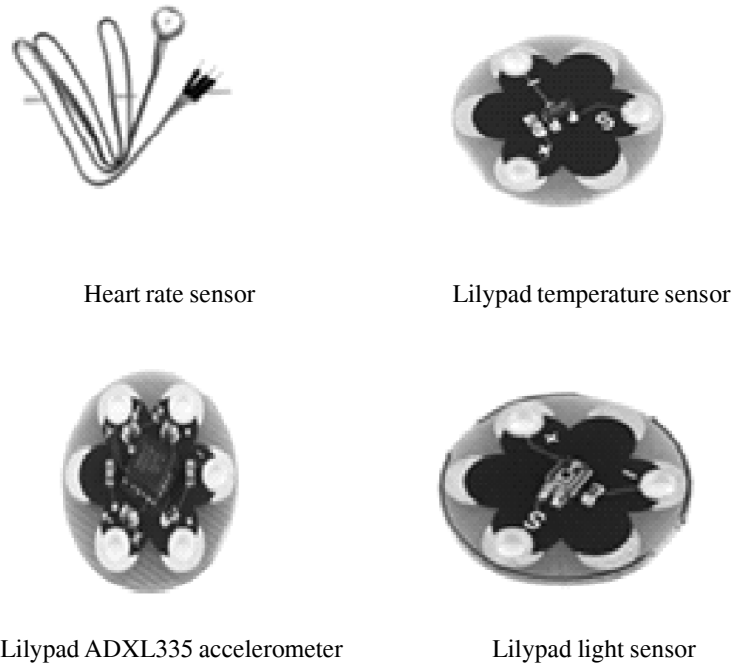

Figure 2: Wearable sensors in HAR

(a) Physiological signals: According to the previous studies, they concluded that there is no need of heart rate sensor in a HAR context. Vital signs data (e.g., heart rate, respiratory rate) have also been considered along with triaxial accelerometers for data analysis³ in activity recognition. So that by means of structural feature extraction, vital signs can be exploited to improve accuracy. In order to measure physiological signals, additional sensors would be required, thereby increasing system performance.

Heart rate sensor is really useful in daily exercise routine, activity studying and anxiety levels. But heart rate is difficult to measure. The pulse sensor can solve that problem and it is a plug-and-play heart rate sensor for Arduino. This heart rate sensor has amplification and noise cancellation circuitry because of this feature it will give reliable pulse readings.

(b) Environment attributes: The attributes, such as temperature, light, etc., are intended to provide certain information regarding the individual's environments.

Wearable Lilypad light sensor is simple to use that outputs an analog value from 0 to 5V. With exposure to daylight, this sensor will output 5V. The output of the sensor when covered with hand will be 0V. In a normal lighting condition, the sensor will output from 1 to 2V.

Lilypad temperature sensor is a small MCP9700 thermistor type temperature sensor. This sensor will output 0.5V at 0 degrees C, 0.75V at 25 C, and 10mv per degree C. Doing ADC on the signal line will allow establishing the ambient temperature. Detection of body temperature by physical touch⁵ is not that easy because it differs from area to area in human body.

(c) Acceleration: Trail axis ADXL335 Lilypad accelerometer is broadly used sensors to recognize person's activities. This accelerometer² can detect joint movement as well as inclination and vibration. The ADXL335 outputs a 0V to 3V analog signal on each of the X, Y, and Z axis. Accelerometer requires relatively low power, inexpensive. Because of this feature this sensor unit is taken as wearable sensor which has high accuracy and flexibility.

3.2. Acceptability level

The accuracy of activity recognition, especially those based on the level of acceptability of wearable sensors, is highly affected by the training and testing stages^{2,7}. In HAR systems the user should not wear many sensors because these configurations may be expensive, invasive and hence not suitable for activity recognition. If we conduct the training and testing experiments⁴ on the same subject achieves the highest accuracy. The accuracy decreases when the test data are collected in one day and training performed on the different day for the same subject.

3.3. Performance recognition

The performance of a HAR system depends on set of activities, training data quality, method used in feature extraction, learning algorithm for pattern recognition. Complexity of the user activities are the key challenges⁴ in performance recognition. For example, people performing multiple tasks at the same time then the classifier might confuse. So there is a need of classifier which is trained by suitable algorithm to recognize difficult and multiple activity patterns.

3.4. Energy consumption

Activity recognition applications require continuous sensing and updating the data for testing and training the behavioral patterns. So, extending the battery life is a desirable feature in recognizing complex activities for military and medical applications. Factors for energy consumption are mainly data processing, communication⁴ and pattern recognition. Wearable communication module (Lilypad XBee) is used for data transmission and reception, which is a short range³ wireless network and requires lower power shown in table.

Table 1
Specifications of wireless Zigbee communication module

<i>Standard</i>	<i>Range</i>	<i>Bandwidth</i>	<i>Data rate</i>	<i>Applications</i>
Zigbee module	100m	2.4GHz	250-500 kbps	Wireless sensors

3.5. Flexibility

A flexible, light weight and robust antenna⁵ can play a major role in wireless power transmission related to wearable sensors. This system is designed with e-textile components that are easily attached to the clothes.

Particularly, the Lilypad textile sensors are most flexible and are very attractive. They give most accurate results for complex human activities also. So that it is easy to handle and is very comfortable for elderly people to recognize their daily life activities.

4. ACTIVITY RECOGNITION METHODS

Activity recognition consists of environment and behavior monitoring, activity modeling, data processing⁶ and pattern recognition. Figure 3 explains three main components in design and development of HAR system:

- ❖ Placement of sensors on human body
- ❖ Pre-processing of data with feature extraction/selection
- ❖ Data classification

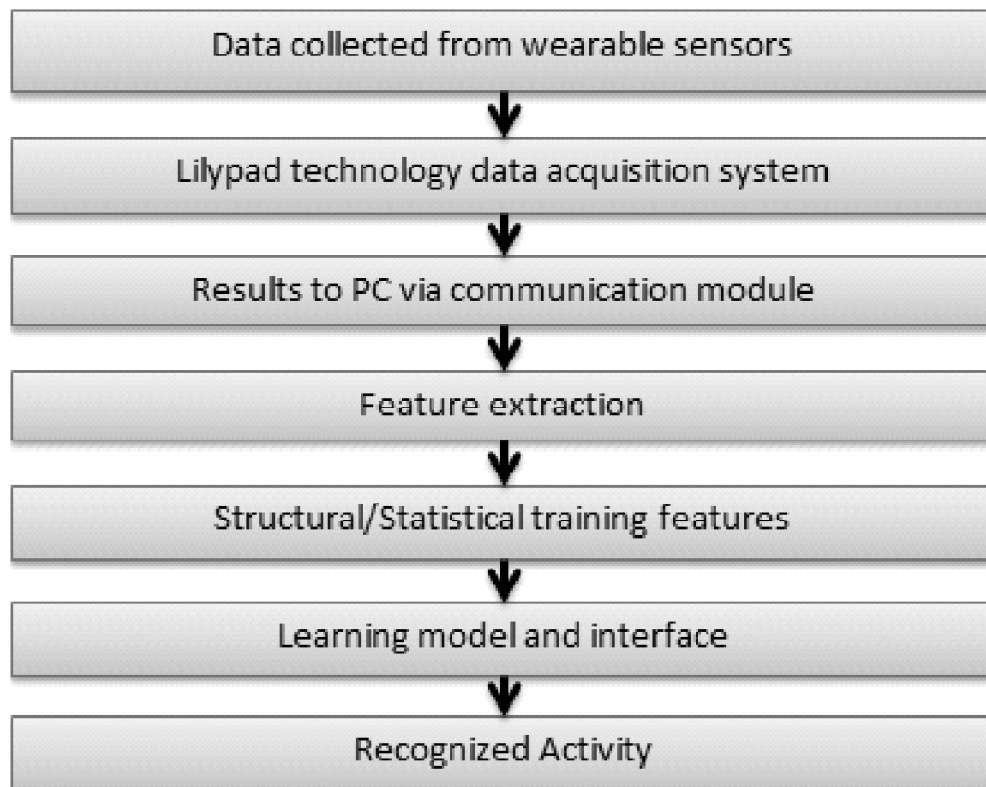

Figure 3: Steps involved in Human activity recognition

Wearable sensor placement

The acceleration sensor worn by different healthy subjects were placed⁸ at key points of lower/upper body limbs such as chest, waist, right thigh and left ankle. This is a crucial task to place an accelerometer on human body to recognize the complex human activities of daily life.

Placement of number of wearable sensors reduces the accuracy of measurement, so that our design contains only four wearable sensors (Lilypad accelerometer, Lilypad temperature, Lilypad light, wearable heart rate sensor). Depending upon the placement of acceleration^{1,2} unit the recognition performance may differ. The results showed that the sensor placed on the hip gives exact measures to recognize most of daily life activities.

Processing of data

The data from the wearable sensors is collected by using Lilypad Arduino and the appropriate values from the sensors are processed with Matlab Simulator. Processing involves basically⁶ two stages: testing and training. The raw data from the wearable sensors can be taken as a matrix form and the results of the sensors are featured using neural network algorithm. The features can be extracted by using proper statistical methods.

$$Data\ from\ wearable\ sensors = \begin{bmatrix} a_{1x1} & a_{1y1} & a_{1z1} & \Theta_{1x1} & \Theta_{1y1} & \Theta_{1z1} & m_{1x1} & m_{1y1} & m_{1z1} & T_1 & L_1 \\ a_{1x2} & a_{1y2} & a_{1z2} & \Theta_{1x2} & \Theta_{1y2} & \Theta_{1z2} & m_{1x2} & m_{1y2} & m_{1z2} & T_2 & L_2 \\ \vdots & \vdots & \vdots & \vdots & \vdots & \vdots & \vdots & \vdots & \vdots & \vdots & \vdots \\ a_{1xn} & a_{1yn} & a_{1zn} & \Theta_{1xn} & \Theta_{1yn} & \Theta_{1zn} & m_{1xn} & m_{1yz} & m_{1zn} & T_n & L_n \end{bmatrix}$$

Where a_{1x} , a_{1y} , a_{1z} are the three axis acceleration, θ_{1x} , θ_{1y} , θ_{1z} are the angle of rotation on three axes, m_{1x} , m_{1y} , m_{1z} are the magnetization on three axes, T is temperature, L is the brightness, and n is number of samples acquired.

Pattern recognition from these matrixes is analyzed and then the data is classified⁴ as per activity. The accuracy of the pattern recognition is depending upon the type of learning algorithm that is used in training.

Data classification

The data that can be extracted from the statistical methods can be classified according to the set of behavior patterns and there by activity will be recognized. Classification of data mainly based on⁵ the motion of different body parts, depending on the type of activity. For example, the whole body involved in activities like walking and cycling.

This design mainly deals with the classification of daily living human activities using wearable sensors. Walking, cycling, running, standing, sitting, upstairs, down stairs, falling down etc. are examples of basic activities shown in figure 4. We conducted repetitive experiments on 5 people (average age 35) and measured 12 daily life activities with behavioral patterns.



Figure 4: Common daily life activities

Table 2
Activities and their descriptions in HAR

<i>Activity</i>	<i>Description</i>
Walking	The person walks forward along a straight road
Running	The person runs forward at normal speed
Cycling	The person performs cycling exercise
Standing	The person stands still without any work
Sitting	The person sits on a chair either working or resting
Bending	The person bends body towards ground
Upstairs	The person goes up
Down stairs	The person goes down
Falling down	The person falls down suddenly
Turn left/right side	The person turns the body to his left/right side
Lying	The person in rest position/sleepy
Head movements	The person moves head in clockwise/anti clock wise direction

The common activities and their descriptions in people’s daily life shown in Table 2. which are useful for both elder care and patients with chronic diseases^{1,5}.

5. ACTIVITY ANALYSIS AND RESULTS

In activity recognition the data from the accelerometer⁴ is the important parameter than other sensor because it gives results in position and body movement. Figure 5 shows the pattern analysis of raw data from three axis wearable accelerometer.

The data from the heart rate sensor⁶ is mandatory when the person is doing their exercise routine and is very helpful for elder people. Detecting the heart rate data is a crucial factor in activity recognition. The heart rate of the person while running is taken as a parameter for analysing and is explained in figure 5.

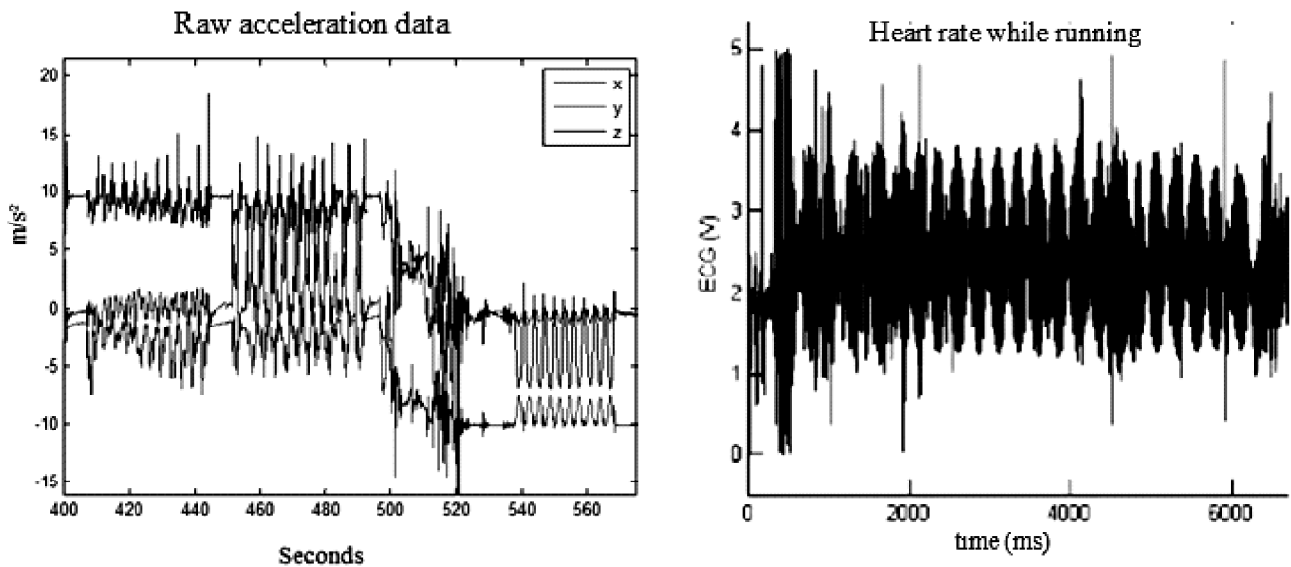

Figure 5: Pattern analysis of accelerometer and Heart rate analysis for running activity

The data collected from the wearable sensors is collected by the arduino and the heart rate is measured and is displaying on the LCD screen shown in figure 6.

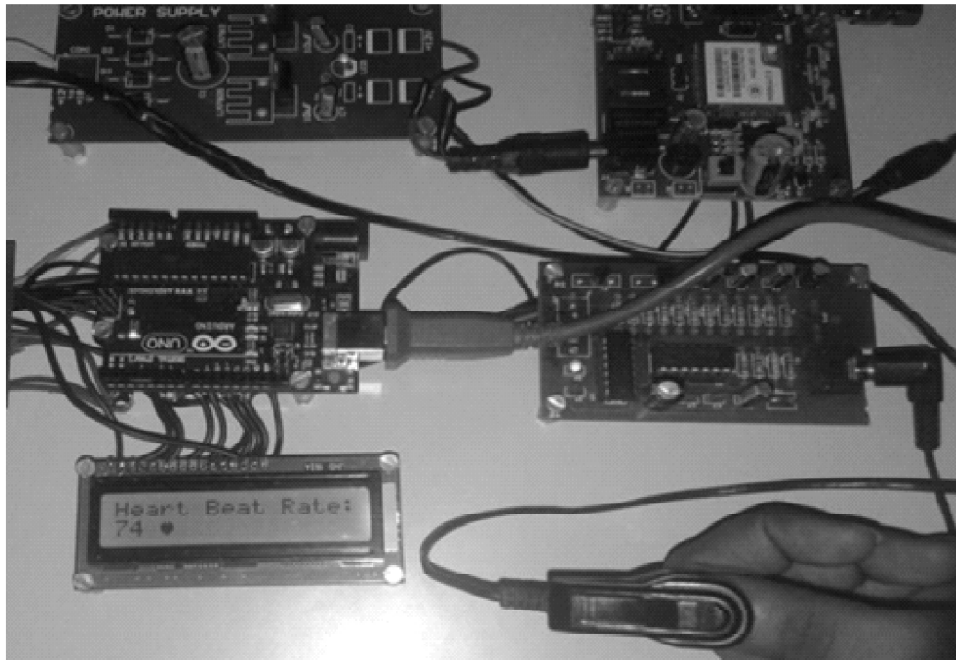
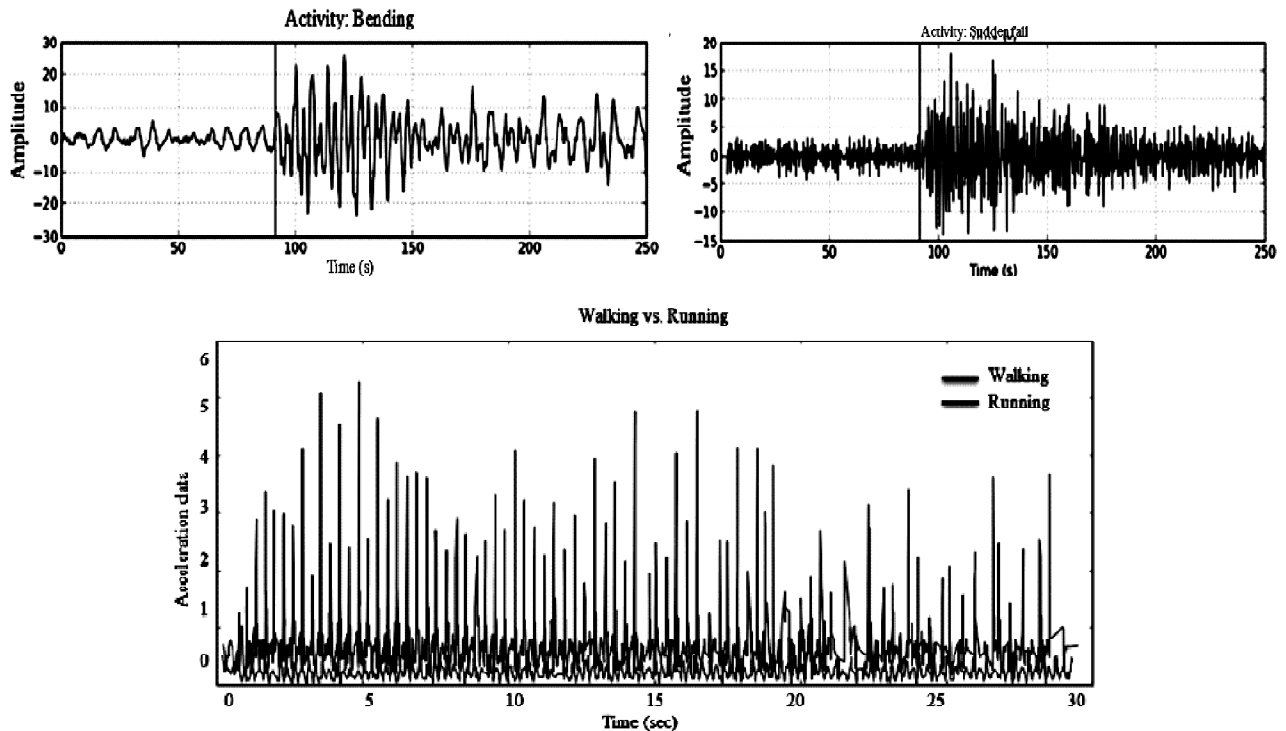

Figure 6: Receiver system displaying heart rate

Pattern behaviors for activities performed⁷ after tesing and trained by learning algorithm. The simulation results after pattern analysis for some of the activities bending, sudden fall, walking, running are shown below.



The performance of the classifier for evaluation of activities by using neural networks has several features. The accuracy of the classifier⁵ may vary according to the type of activity and pattern overlapping. The classifier performance in percentage with respect to window time for different activities is shown in figure 7.

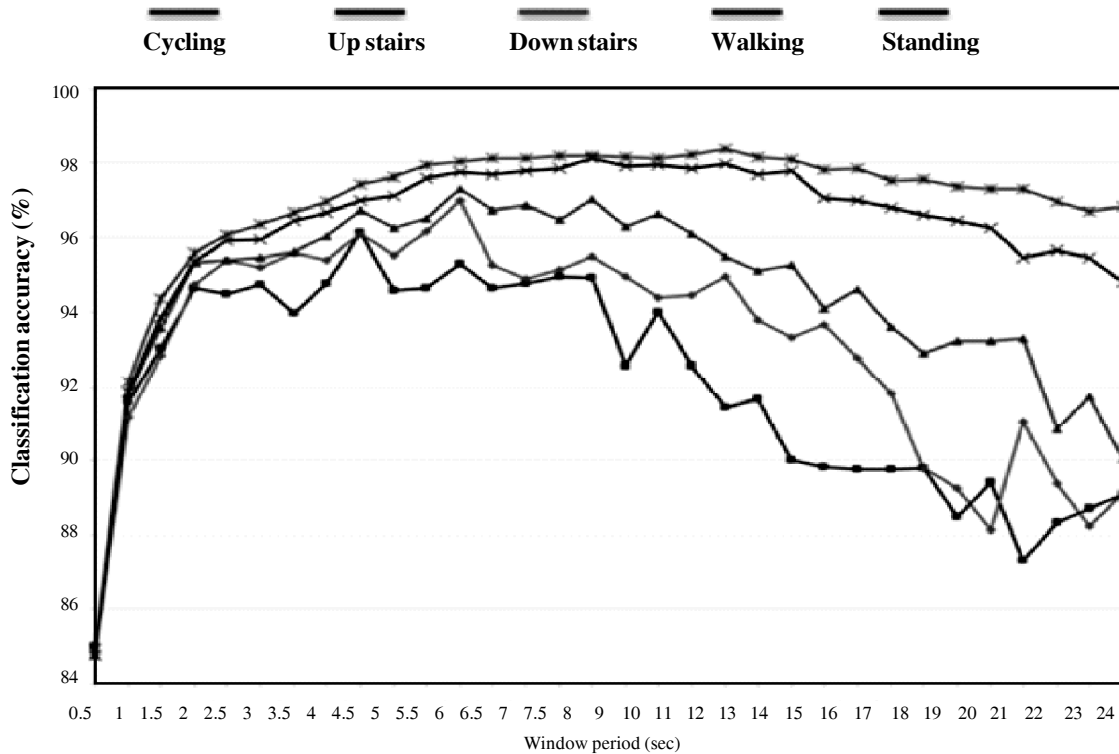

Figure 7: Classifier accuracy for daily activities

5. CONCLUSION

In this paper we designed a body area network with e-textile sensors, to acquire data according for body position and movements. This system gives reliable information as per the person’s behavior and corresponding activities are detected. Usage of recording sensors for the wearable system may give exact results about human activity recognition and can be useful in real- time tracking for further analysis.

REFERENCES

- [1] Subhas Chandra Mukhopadhyay, *Fellow*, IEEE “Wearable Sensors for Human Activity Monitoring: A Review” IEEE SENSORS JOURNAL, VOL. 15, NO. 3, MARCH 2015.
- [2] Muhammad Arif, Ahmed Kattan, “Physical Activities Monitoring Using Wearable Accelerometer Attached to the Body” PLOS One. 2015; 10(7): e0130851.
- [3] Orha, S. Oniga, “Activity Recognition using an e-Textile Data Acquisition System” 2015 IEEE 21st International Symposium for Design and Technology in Electronic Packaging (SIITME).
- [4] James L. Crowley, Kai Kunze, Paul Lukowicz, Albrecht Schmidt “Human Activity Recognition in Smart Environments” Report from Dagstuhl Seminar 12492.
- [5] Oscar D. Lara and Miguel A. Labrador “A Survey on Human Activity Recognition using Wearable Sensors”.

- [6] Jubil T Sunny, Sonia Mary George “Applications and Challenges of Human Activity Recognition using Sensors in a Smart Environment” IJIRST –International Journal for Innovative Research in Science & Technology, VOL. 2, ISSUE 04, September 2015, ISSN(online): 2349-6010.
- [7] ANDREAS BULLING, ULF BLANKE, BERNT SCHELE “A Tutorial on Human Activity Recognition Using Body-Worn Inertial Sensors” ACM Computing Surveys, Vol. 46, No. 3, Article 33, Publication date: January 2014.